

INSERT - ENGINEERS (V2.4)**WARNING**

ALTHOUGH NOT CLASSIFIED, THIS PUBLICATION, OR ANY PART OF IT, MAY BE EXEMPT FROM DISCLOSURE TO THE PUBLIC UNDER THE ACCESS TO INFO ACT. ALL ELMS OF INFO CONTAINED HEREIN MUST BE CLOSELY SCRUTINIZED TO ASCERTAIN WHETHER OR NOT THE PUBLICATION OR ANY PART OF IT MAY BE RELEASED.

Issued on Authority of the Chief of the Land Staff

OPI: DAD 6

2000-03-01

LIST OF EFFECTIVE PAGES

Insert latest changed page; dispose of superseded pages in accordance with applicable orders.

NOTE

The portion of the text affected by the latest change is indicated by a black vertical line in the margin of the page. Changes to illustrations are indicated by miniature pointing hands or black vertical lines.

Dates of issue for original and changed pages are:

Original.....	0	2000-03-01	Ch.....	2
Ch.....	1		Ch.....	3

Zero in Change No. column indicates an original page. Total number of pages in this publication is 159 consisting of the following:

Page No.	Change No.	Page No.	Change No.
Title	0		
ii-iv	0		
8-1 to 8-155	0		

Contact Officer: DAD 6

TABLE OF CONTENTS

PART 8 - ARM INSERT.....	8-1
TAM - 805 ENGINEERS PLANNING DATA AND ORDERS	8-1
805.01 - Engineer Vehicles and Trailers Characteristics.....	8-1
805.02 - Threat Engineer Equipment.....	8-5
805.03 - Obstacle Crossing Capabilities of Main Battle Tanks	8-11
805.04 - Combat Engineer Regiment Command Radio Net Diagram.....	8-13
805.05 - Densities of Common Materiel	8-13
805.06 - Weight of Common Defence and Construction Materiel.....	8-14
805.07 - Engineer Estimate	8-14
805.08 - Flocark	8-17
805.09 - Engineer Orders – Execution Paragraph.....	8-19
805.10 - Briefings.....	8-22
805.11 - Engineer Reconnaissance – General.....	8-24
805.12 - Route Reconnaissance	8-25
805.13 - Road Standards.....	8-31
805.14 - Drainage.....	8-32
805.15 - Surface Expedients and Trackway.....	8-35
805.16 - Road Repairs	8-36
805.17 - Safe Angle Of Repose and Safe Bearing Pressure.....	8-36
805.18 - Field Machines and Rigging.....	8-37
805.19 - Gap Crossing Reconnaissance Checklist.....	8-42
805.20 - Armoured Vehicle Launched Bridging.....	8-44
805.21 - Medium Girder Briging (MGB).....	8-47
805.22 - Medium Raft/Medium Floating Bridging.....	8-60
805.23 - Military Load Class Tables.....	8-63
805.24 - Line of Communications Bridging – ACrow	8-67
805.25 - Mgb Overbridging.....	8-69
805.26 - Engineer Boats	8-70
805.27 - Aslt Boat Crossing Layout	8-71
805.28 - Ferry Site Layout.....	8-71
805.29 - Counter Mine Eqpt.....	8-72
805.30 - Barrier Planning	8-73
805.31 - Canadian Mines and Vehicle Mine Carrying Capacity	8-75
805.32 - Allied Scatterable Mines Data.....	8-78
805.33 - Minelaying.....	8-79
805.34 - Minefield Lane Marking.....	8-82
805.35 - Booby Traps	8-83
805.36 - Bridge Categorisation	8-85
805.37 - Methods of Atk for Simply Supported Spans	8-86
805.38 - Methods of Atk for Continuous Spans	8-103
805.39 - Demolitions - General.....	8-121
805.40 - Cutting Charges for Round Steel Bar and Steel Wire Rope.....	8-124

TABLE OF CONTENTS (continued)

805.41 - Cutting Charges for Rectangular Timber.....	8-126
805.42 - Cutting Charge Masonry and Un-reinforced Concrete	8-129
805.43 - Cutting Charge Rectangular Steel	8-131
805.44 - Breaching Charges.....	8-135
805.45 - Borehole Charges	8-138
805.46 - Mined Charges.....	8-142
805.47 - Concussion Charges	8-147
805.48 - Explosive Digging	8-148
805.49 - Firing Circuits.....	8-148
805.50 - Water Sup.....	8-149
805.51 - Construction Materials	8-152
805.52 - Data Types	8-154
805.53 - Geospacial Products	8-154

PART 8 - ARM INSERT

TAM - 805 ENGINEERS PLANNING DATA AND ORDERS

805.01 - ENGINEER VEHICLES AND TRAILERS CHARACTERISTICS

Ser	Eqpt (Abvn)	Crew	Armt	DIMENSION (m)			MLC	MAX SPEED(km/h)		Ford Depth (m)	Remarks
				L	W	H		Rd	Cross Country		
(a)	(b)	(c)	(d)	(e)	(f)	(g)	(h)	(i)	(j)	(k)	(l)
1	AEV Badger	3	2 x GPMG (one with AA mount)	8.93	3.25	2.57	50	62	40	w/o kit 1.20 deep fording 2.25 w/schorkel 4.00	Has dozer blade, scarifiers, winch, boom crane, and bucket
2	AVLB Beaver	2	Pers wpns 8 x smk dischargers	11.82 (10.56)	4.00 (3.3)	5.60 (2.56)	50 (37)	62	40	w/o kit 1.20 w/schorkel 1.70	Has 22 m br which spans 20 m Figures in brackets are for AVLB w/o a br
3	Carrier, Pers, Full Trk, M113A1 Cdn, w/Bulldozer, Earth Moving	1 dvr 8 pers		5.88	2.95	2.2	11	42.5			Max towing ld 7,272 kg External fuel tanks Earth auger
4	Truck, Fd Engr, 2 1/2 t, 6x6, MLVW	1		7.98	2.54	3.16	12	90			Winch Capacity 4530 kg Cable length 66 m Cable size 12.7 mm
5	Truck Pallet Loading, 6X6, 15 t (Kenworth C520)	2	Pers wpns	9.957	2.674	3.302	30				Max allowable payload 13,608 kg
6	Hy Engr Sp Veh (Western Star 4866S)	2	Pers wpns	10.566		3.296			-		Payload 15 t Pallet loading system with dump module Towing capacity 18 t
7	Truck, Tractor, 10 t, 6x6, HLVW	2	Pers wpns	8.2	2.426	3.255	15	90		0.8	Hauls semi-trl with engr eqpt



Ser	Eqpt (Abvn)	Crew	Armt	DIMENSION (m)			MLC	MAX SPEED(km/h)			Remarks
				L	W	H		Rd	Cross Country	Ford Depth (m)	
(a)	(b)	(c)	(d)	(e)	(f)	(g)	(h)	(i)	(j)	(k)	(l)
8	Truck, Med Floating Br Tpt/ Dismountable Flat Rack System, 10 T, 6x6 HLVW	2	Pers wpns	9.32	2.44	3.425	26	90	-	0.8	Carries MR pontoon
9	Crane, Truck Mounted, 60 T, 8x4 (Grove TMS 300B)	1	Pers wpns	13.4	2.44	3.3	36	82.9	-		Counter Wt 3,493 kg Cable length 152 m
10	Crane, Wh Mounted, 4x4, All Terrain, 20 t (Krupp KMK 2025)	1	Pers wpns	9.82	2.49	3.29	40	78	-		Lift capacities: on outriggers, 3.05 m reach 22,8 t on tires, 3.05 m reaches 7,900 kg on rubber tires over front, pick and carry 9 t
11	Tractor Wh Industrial, with Front End Loader and Backhoe (Case 590Supper L)	1	Pers wpns	7.112	2.438	2.718	11	42.3	-		With 4-in-1 loader bucket
12	Grader, Rd, Motorized, 6x4 (Champion 730R)	1	Pers wpn	8.433	2.553	3.353	14	43.5	-		Accessories incl rear mounted wing, ripper with 5 removable teeth and V-plough
13	Excavator, Multi-purpose, Wh Mounted (Case (Cruz Air) 1085B)	1	Pers wpn	9.195	2.438	3.861	30	45	-		
14	Excavator, (Case Drott 45 Cruz-Air)	1	Pers wpn	9.8	2.4	4.1	30	25			



Ser	Eqpt (Abvn)	Crew	Armt	DIMENSION (m)			MLC	MAX SPEED(km/h)			Remarks
				L	W	H		Rd	Cross Country	Ford Depth (m)	
(a)	(b)	(c)	(d)	(e)	(f)	(g)	(h)	(i)	(j)	(k)	(l)
15	Tractor, Wh, High Mob, 4X4, Earth Moving Dozer (Zettelmeyer ZD-3000)	1	Pers wpn	8.20	2.73	3.302	32	40	-	1.20	Winch cable length 84 m Max pull 20 t
16	Tractor, Wh, High Mob, Lder (Zettelmeyer ZL-5001 F)	1	Pers wpn	9.550	3.0	3.35	32	55			Accessories – quick connect lifting beam, crane and forklift 4-in-1 bucket 3.5 m ³ capacity Snow bucket 6.0 m ³ capacity
17	Tractor, Low Speed, Full-Trked, Armd Cab (Caterpillar D6D)	1	Pers wpn	5.766	3.890	3.150	34	11	-		
18	Roller, Hy Duty, Self Propelled (Case W 602B)	1	Pers wpn	4.405	1.860	2.817	7				
19	ADI High Speed Engr Veh (MPEV)	1	Pers wpn	8.6	2.5	2.6		100			Incl front end loader and backhoe Bucket capacity is 1.0 m ³
20	Loader, Scoop, 4x4, Articulated Frame Steer (Case MW24C)	1	Pers wpn	6.985	2.54	3.378	13	35.5			Ht without cab is 2.591 m 4-in-1 bucket 1.91 m ³ capacity Snow bucket 3.06 m ³ capacity
21	Lder, Scoop Type, Skid Steer, 4x4 (RAMROD 584)	1	Pers wpn	3.25	1.575	2.015		10			
22	Roller, Towed, Sheep's Foot Model – H Series	-	-	4.32	3.0						Grd pressure empty – 105.45 t/m ² Grd pressure ballasted – 168.72 t/m ² Length of feet – 7 in No of tamping feet - 104

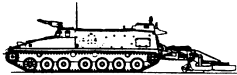
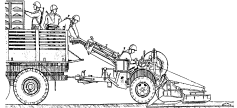
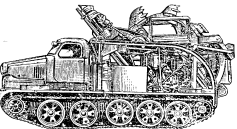

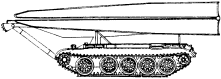
Ser	Eqpt (Abvn)	Crew	Armt	DIMENSION (m)			MLC	MAX SPEED(km/h)			Remarks
				L	W	H		Rd	Cross Country	Ford Depth (m)	
(a)	(b)	(c)	(d)	(e)	(f)	(g)	(h)	(i)	(j)	(k)	(l)
23	Roller, Towed, Pneumatic Tire (WRT Model PT 13)	-	-	4.788	2.223	1.168					Ballast capacity – 3.4 m ³
24	Roller, Towed, Vibrating (Dynapac Model CH 47)	-	-	4.81	2.13	1.45					Working speed 3-6 kph Tpt speed 8 kph Suitable Towing Vehs: in gravel, sand, coarse moraine, clay and rock fill – tractor wt 3-6 t, 50-80 hp in dry sand, wet clay – tractor wt 8-12 t, 60-100 hp
25	Trl, Beaver Tail, Tilt Deck (BWS Model 21TT102)			8.69	2.59	.91		80	48		Total capacity 18,2 t
26	Trl, Beaver Tail, Tilt Deck (Craig Model TA-15)			7.8	2.6	.908					Total capacity 13,6 t
27	Semi-Trl, Lowbed, 35 t, Variable Deck Ht (Arnes 204-586- 01R)			13.411	2.591						Total capacity 35 t Fold down gooseneck Tandam axle Deck length 6.909 m
28	Mine Layer Mech (FFV 5821)	-	-	5.27	2.48	2.1	2	-	Max laying speed 7 km/hr		Hauled by HLVW with 8metal mine racks @ 90 mines/rack 720 total Suggested 4 pers to op Max plough depth 20 cm Minelaying Capacity: buried 300 mines/hr surface 500 mines/hr Mine spacing 6, 7.5 or 10 m



805.02 - THREAT ENGINEER EQUIPMENT

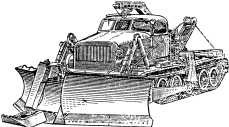

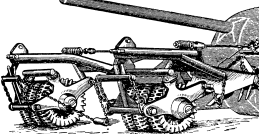
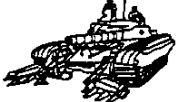
Eqpt	Tech Characteristics	Issue Scale	Remarks
<p>GMZ Armd Mine Layer</p> 	<p>Speed of Laying: 200 mines in 20 min</p>	<p>3 - Div Engr Bn</p>	<p>Fully armd</p>
<p>PMR-3 Mech Mine Layer</p> 	<p>Speed of Laying: surface: 10 km/h buried: 3 km/h Reled: 10-12 min</p>	<p>3 - MR and Tk Regt Engr Coy 3 - Front Engr Bde 8 - Army Engr Regt</p>	<p>Towed by BTR-152, which carries 180 mines, or by truck</p>
<p>BTM/BTM-3 Ditching Machine</p> 	<p>Digs Ditch: 1.5 m deep, 1.0 m wide (top), 0.6 m wide (bottom), 0.4 m high parapet, at rate of 1120 m/hr</p>	<p>1 - MR and Tk Regt Engr Coy 2 - MR and Tk Div Engr Bn</p>	<p>Uses AT-T chassis</p>

Eqpt	Tech Characteristics	Issue Scale	Remarks
	Ld Capacity: 50 t Length: 20 m Max Span: 18 m Launch Time: 5 min Rec Time: 5-7 min	1 -MRR Engr Coy 3 -Tk Regt Engr Coy	Scissor type br
	Ld Capacity: 50 t Length: 20 m Max Span: 18 m Launch Time: 5 min Rec Time: 5-7 min	1 - MRR Engr Coy 3 - Tk Regt Engr Coy	Scissor type br
	Ld Capacity: 60 t Length of Unit: 10.5 m Set of 4 Units: 42 m Max Trestle Height: 3.2 m Launch and Rec Time: 45-60 min	4 - MR and Tk Regt Engr Coy 8 - Div Engr Bn	Mtd on KRAZ-255B

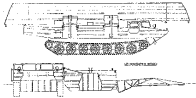
Eqpt	Tech Characteristics	Issue Scale	Remarks
PMP Pontoon Br/Ferry 	Ferry: CI 60 Br: 18 sects for 119 m CI 60, or 191 m CI 20 Const Time: 7 m/min	18 - Div Engr Bn	Can be used with TMM with 11.5 m overlap
IMR Armd Engr Tractor 	Straight, "V", or angled 3.5 m blade Bucket: 0.15 m ³ Jib and Grab: 4000 kg lift	2 -Div Engr Bn	Armd and NBC protected
BAT M/BAT-2 Trked Engr Veh 	Dozer, 2 sects, adaptable from straight to "V" blade 2000 kg rotary crane mounted on rear Max slope: 55% Max ford: 0.8 m	1 - MR and Tk Regt Engr Coy 8 - MR and Tk Div Engr Bn	Based on AT-T chassis

Eqpt	Tech Characteristics	Issue Scale	Remarks
	<p>Speed of Clearing: 8-10 km/h</p> <p>Width of Path Cleared per Trk: 0.8 m</p> <p>Can survive 8 to 10 5/6 kg explosions</p>	<p>9 - Tk Regt Engr Coy</p> <p>3 - MR Regt Engr Coy</p> <p>3 - Tk Bn</p>	<p>Rollers and plough cannot op at same time</p> <p>Rollers primarily for recce</p> <p>Has chain sweep</p>
	<p>Speed of Clring: 10 km/h</p> <p>Path Clred: 0.1 m deep, 0.7 m wide</p>	<p>27 - Tk Regt Engr Coy</p> <p>9 - MR Regt Engr Coy</p>	<p>Ploughs normally remain mtd on tks.</p>
	<p>110-250 m³/hr</p> <p>Max Width: 3.4 m</p> <p>Max Slope: 55%</p>	<p>3 - MR and Tk Regt Engr Coy</p>	<p>3 blades per tlr</p>

Eqpt	Tech Characteristics	Issue Scale	Remarks
<p data-bbox="121 163 397 189">GSP Trked Folding Ferry</p> 	<p data-bbox="490 163 760 282">2 GSP vehs reqr to form one CI 50 GSP ferry Assy Time: 3-5 min Speed in water: 8 km/h</p>	<p data-bbox="786 163 971 189">6 - Div Engr Bn</p>	<p data-bbox="1114 163 1534 282">No limit to no of spans which can be joined Must have at least 1.2 m draft and max 0.5 m bank ht at loading site</p>
<p data-bbox="121 365 370 391">PTS Trked Amphibian</p> 	<p data-bbox="490 365 760 578">Capacity: 5t land, 10t or 70 pers water Water spd: 15 kph max (takes 70% longer with PKP) Max slope climb: 27% when fully loaded</p>	<p data-bbox="786 365 1092 422">12 PTS + 3 PKP Tlrs in Div Engr Bn</p>	<p data-bbox="1114 365 1502 422">Use of PKP tlr allows simultaneous crossing of gun and prime mover</p>
<p data-bbox="121 586 479 612">MDK-2 Trked Ditching Machine</p> 	<p data-bbox="490 586 781 705">1.5 m depth per pass, max of 3 passes Digs 300 m³/hr, or 50 m/hr of AT ditch</p>	<p data-bbox="786 586 971 612">2 - Div Engr Bn</p>	<p data-bbox="1114 586 1328 612">Mtd on BTR 50 PK</p>

Eqpt	Tech Characteristics	Issue Scale	Remarks
UR-67 Mine Clearing Rocket 	Clears 2 lanes 50 m by 7 m before reloading 75-90% clr	2 - Div Engr Bn	
DIM Mine Detector 	Sweeps at 14 km/h, 2.2 m width, 0.25 m deep Auto-stop on detecting mine.	3 - Div Engr Bn	

805.03 - OBSTACLE CROSSING CAPABILITIES OF MAIN BATTLE TANKS

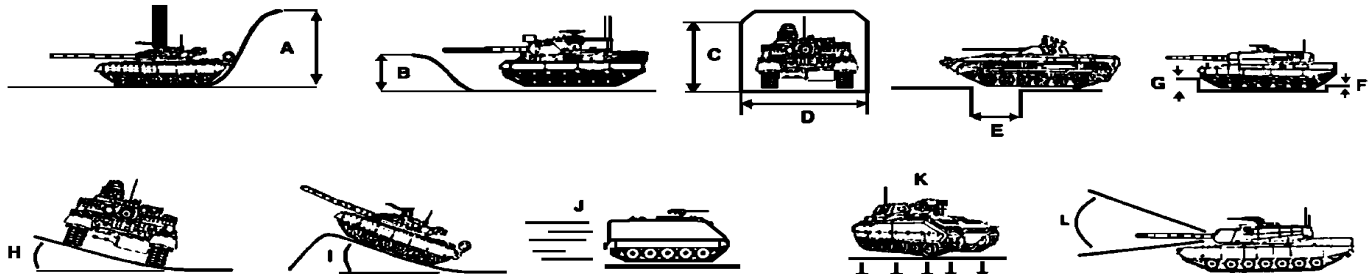

TK MODEL	A Water Crossing Snorkel or with prep (m)	B Water Ford w/o prep (m)	C Ht to Clr (m)	D Width to Clr (m)	E Max Gap (m)	F Grd Clear (m)	G Max Step (m)	H Max Tilt (%)	I Max Grad (%)	J Max Rd Speed (kph)	K Grd Pres (kg/cm ²)	L Gun Depres/ Elev (°)
M60A3	2.40	1.22	3.27	3.63	2.59	.45	.91	30	60	48.3	0.87	-10/+20
M48A5	2.44	1.22	3.09	3.63	2.59	.42	.91	40	60	48.2	0.88	-9/+19
M47	---	1.22	3.35	3.51	2.59	.47	.92	40	60	48.0	0.94	-5/+19
M1 Abrams	2.38	1.22	2.89	3.66	2.74	.48	1.25	40	60	72.4	unk	-9/+20
Leopard A1	4.00	2.25	2.62	3.25	3.00	.44	1.15	30	60	65.0	0.66	-9/+20
Chieftain	---	1.07	2.90	3.51	3.15	.51	.91	40	60	48.0	0.9	-10/+20
Challenger	---	1.07	2.95	3.52	2.8	.50	.90	40	58	56.0	0.97	-10/+20
Leclerc	---	1.0	2.47	3.71	3.0	.50	1.25	30	60	75.0	0.9	-8/+15
AMX 30	4.00	1.3	2.86	3.10	2.90	.45	.93	30	60	65.0	0.77	-8/+20
T-55	4.55	1.40	2.90	3.27	2.70	.43	.83	40	60	48.0	0.81	-4/+17
T-64	5.00	1.80	2.27	3.37	2.28	.38	.80	40	60	75.0	0.86	-6/+14
T-72	5.00	1.80	2.37	3.60	2.80	.47	.85	40	60	80.0	0.84	-5/+18
T-80	5.00	1.80	2.25	3.40	2.85	0.38	1.00	40	60	70.0	0.86	-5/+14
PT-76	Amph	Amph	2.26	3.14	2.8	0.37	1.1	35	70	44.0	0.48	-4/+30

SOURCE: JANE'S AFV RECOGNITION HANDBOOK, SECOND EDITION, 1992.

APC MODEL	A Water Crossing Snorkel or with prep (m)	B Water Ford w/o prep (m)	C Ht to Clr (m)	D Width to Clr (m)	E Max Gap (m)	F Grd Clear (m)	G Max Step (m)	H Max Tilt (%)	I Max Grad (%)	J Max Rd Speed (kph)	K Grd Pres (kg/cm ²)	Remarks
APC (wheeled)												
LAV-25	Amph	Amph	2.70	2.5	2.06	.5	.5	40	70	100.0	unk	Wt: 12.8
AVGP	Amph	Amph	2.53	2.53	unk	.39	.51	30	60	101.5	unk	Wt: 10.5
BISON	Amph	Amph	2.21	2.50	2.06	unk	.51	30	60	100.0	unk	Wt: 12.8
BTR-80	Amph	Amph	2.36	2.90	2.0	.48	.5	30	60	80.0	unk	Wt: 13.6
APC (tracked)												
M113A2	Amph	Amph	2.52	2.69	1.68	.43	.61	40	60	67.0	.56	
M2 Bradley	Amph	Amph	2.98	3.2	2.54	.43	.91	40	60	64.0	.54	
AAV7A1	Amph	Amph	3.27	3.27	2.44	.41	.91	60	60	64.0	unk	Wt: 22.88
Marder 1	2.6	1.5	2.99	3.24	2.5	.44	1.0	30	60	75.0	.83	
Spartan	Amph	1.07	2.26	2.25	2.05	.36	.5	35	60	80.5	.34	
Warrior	---	Amph	2.80	3.04	2.5	.49	.75	40	60	75.0	.65	
AMX-10P	Amph	Amph	2.57	2.78	2.1	.45	.7	30	60	65.0	.53	
BMD-2	Amph	Amph	1.98	2.63	1.6	.45	.8	30	60	70.0	.57	
BMP-2	Amph	Amph	2.46	3.15	2.5	.42	.7	40	60	65.0	.60	
BMP-3	Amph	Amph	2.46	3.30	2.5	.45	.8	30	60	70.0	.62	
MT-LB	Amph	Amph	1.87	2.86	2.41	.40	.61	30	60	61.5	.46	
AEVs												
M9 ACE	Amph	1.83	2.70	2.80	1.58	.44	.46	20	60	48.3	.64	
M728 CEV	2.44	1.22	3.26	3.70	2.51	.38	.76	30	60	48.2	.89	
Leopard 1	4.0	1.20	2.69	3.75	3.0	.44	1.15	30	60	65.0	.86	
CET	Amph	1.83	3.41	2.92	2.06	.46	.61	30	60	52.0	.44	
AMX-30 CET	4.0	2.5	3.0	3.5	2.9	.45	.9	30	60	65.0	.90	
IMR	unk	1.4	3.37	3.48	2.7	.43	.8	30	60	48.0	.76	
AVLBs												
M60	---	1.22	3.90	4.01	2.59	.36	.91	unk	30	48.0	.92	Span: 18.28
Leopard 1	1.70	1.20	3.55	4.0	2.50	.42	.7	30	60	62.0	.97	Span: 20.0
Chieftain	---	1.07	3.93	4.17	3.0	.5	.9	30	60	48.0	.90	Span: 22.86
MTU-20	---	1.40	2.87	3.27	2.7	.43	.8	40	60	48.0	.76	Span: 12.0
NOTES: 1. Wts are expressed in metric tonnes and relate to the cwt wt of the veh. 2. Span is expressed in meters.												
Source: Jane' s AFV Recognition Handbook, Second Edition 1992.												

805.04 - COMBAT ENGINEER REGIMENT COMMAND RADIO NET DIAGRAM

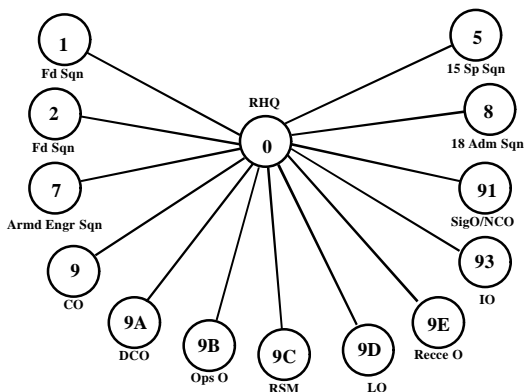

805.05 - DENSITIES OF COMMON MATERIEL

Ser	Mat	Density (t/m^3) metric tonne/metre ³
(a)	(b)	(c)
1	Aluminum Alloy	2.56 - 2.64
2	Brick or Rubble, Compacted	1.6
3	Bricks, Close Packed	1.83 - 2.08
4	Brickwork in Cement Mortar	1.76
5	Chalk, Solid	1.79
6	Clay	1.83 - 2.0
7	Coal	1.28
8	Coke	0.74
9	Concrete, Fresh Mixed, Mass	2.64
10	Concrete, Set, Ltly Reinforced	2.3
11	Earth, Dry to Sodden, Loamy	1.28 - 1.6
12	Gravel and Sand Mixed	1.76
13	Iron, Cast or Wrought	7.20 - 7.67
14	Masonry, Bonded	2.24 - 2.56
15	Sand	1.92
16	Steel	7.84
17	Timber	0.5 - 1.2
18	Water	1.0

805.06 - WEIGHT OF COMMON DEFENCE AND CONSTRUCTION MATERIEL

1. Wt of Plain Wire

a. Standard Wire Gage	8	10	12	14	16	18
b. Wt (kg) of 100 m	11.1	7.4	4.6	2.5	1.5	0.9
c. Length (m) of 51 kg Coil	457	686	1097	2012	3353	5486

2. Wt of Nails

Length of nail (mm)	25	51	76	102	127	152
No per kg	1760	269	117	66	44	31

3. Wt of Barbed Wire, Corrugated Galvanized Iron (CGI) and Pickets

Ser	Item	Unit	Wt (kg)
(a)	(b)	(c)	(d)
1.	Barbed Wire		
	a. 100 m coils	ea	13
	b. Concertinas (15 m)	ea	22.7
2.	CGI Sheets, 0.66m x 1.8m	ea	7.25
3.	Pickets, Metal		
	a. 1.8 m long	ea	5.4
	b. 0.6 m long	ea	1.7

805.07 - ENGINEER ESTIMATE

(CBT EST IS COVERED IN DETAIL IN TAM 101)

NOTE: This table does not presume to be exhaustive. It demonstrates factors and deductions that may be applic to a generic engr est. The engr est will help to decide what type of obs should be used (and where), as well as how to gp res to eff complete all asg tasks.

Ser	Factors	Deductions
(a)	(b)	(c)
1	En	
	<ul style="list-style-type: none"> - Likely en interference (grd, air, NBC) - En str and overall intentions - En engr doc (obs design, breaching and crossing methods) - En engr eqpt 	<ul style="list-style-type: none"> - Protection reqr on task sites (incl sentries, dress, protection parties) - Secur (incl daylight work pol, reqr for concealment, dispersion, rad silence, etc) - Obs design (based on en breaching doc and en engr eqpt aval). Design could incl orientation (based on perceived en approaches and obj)s - Engr int reqrs - Breaching methods

Ser	Factors	Deductions
(a)	(b)	(c)
2	Friendly Forces	
	<ul style="list-style-type: none"> - Comd's overall intent for the battle and fmn depl - Integration of obs with dir fire plans at all levels - Depl of tps loc - Allied and other friendly engrs 	<ul style="list-style-type: none"> - Gives possible add ress aval (incl other engrs, pnrs, etc) - Aval of protection parties (from inf and other arms elms nearby) - Reqr for int - Coord of medevac reqrs - Aval of info/int on area of ops - Gpings for subordinate engr elms
3	Grd	
	Gen (consider the shape of the grd and hydrography, soil conditions, maj obs and rd network)	<ul style="list-style-type: none"> - An eval of grd gen helps determine the possible approaches to be considered and gives a gen idea of how the grd will shape the tac plan - Locs for sqn/tp har, caches, engr dumps, water pts, etc - Soil conditions will determine digging rates and therefore task timings
	- Approaches (Left, Centre, Right)	<ul style="list-style-type: none"> - Approaches are eval based on the obs loc along the approach, the frontage that is possible, the usefulness of the approach (i.e. does it lead to a significant obj – either mine or the en's) - Possible en obs locs may be determined based on an eval of the approaches in to a sector
	- Grd dominating and maj obs on approaches	<ul style="list-style-type: none"> - Possible crossing locs - Order of march (OOM) - Possibility of composite obs - Ress reqr - Gpings and tasks - Time reqr for breaching - Fire sp reqr

1. Grd is probably the most important factor in an engr est. FLOCARK is a very useful tool to eval grd from the engr pt of view. Realize that the engr est is not being conducted in isolation; it occurs as a part of the overall comd's battle procedure, and the two are inter-related.
2. In the def, the comd will eval the grd to determine likely en approaches, rtes and objs. The comd will try and template the en's actions, and will use wargaming to eval various scenarios. Based on his msn he will depl his tps to counter the en. The engr eval of the grd and the tac comd will help decide obs locs and ensure the integration of obs dir and indir fires.
3. During the eval of the grd in a def engr est a no of possible obs might be put on the grd. Depending upon the level at which the est is being conducted,

these would then be ressed and possibly gped into obs gps (sqn level) or belts (regt level). The plotting of indiv obs might be omitted in favour of simply placing obs gps or belts themselves.

4. In the off, the comd eval the grd to determine rtes, objs, and taskings to subordinate fmns. The comd will use his knowledge of the en to try and template the en's depl. The engr eval of the grd will be based on this template. Given the way the comd sees the en depl, how will the en depl his obs effort to sp the def?

5. The order of consideration of Grd and Friendly Forces depends on the sit - either order is acceptable.





Ser	Factors	Deductions
(a)	(b)	(c)
4	Ress Aval	
	<ul style="list-style-type: none"> - Labour - Engr eqpt (CI VII) - Eqpt hy eqpt (CI VII) - Tpt - Const and def stores (CI IV) 	<ul style="list-style-type: none"> - This factor will resemble a shopping list (more or less), and will help estb gpings - Combined with TIME AND SPACE deductions will be able to relate ressed and time into capabilities (i.e. I have 24 tp hrs of labour aval, or I have 3600 m of AT ditch aval) - Ress can also be described in terms of obs design (i.e. I have 2 km of Type C med density minefields)
5	Met	
	<ul style="list-style-type: none"> -Sunrise / sunset -Moonrise / moonset -Visibility and gen met conditions 	<ul style="list-style-type: none"> - Hrs of daylight / darkness - Reqr for TC, guides, and RVs - Effects on pers and wpns systems - Veh mob (particularly cross country mob) - Reqr for rte maint
6	Time and Space	Eval of time and space can be along the same lines as for the tac est
7	Assessment of tasks	
	<ul style="list-style-type: none"> -Completed in tabular form -From grd analysis, list all the obs that must be completed and the ressed reqr to complete them (i.e. tp hrs, AT ditch tm hrs, qty of mines, etc) -At sqn level obs planning resourcing will provide the qtys of pers, eqpt and stores reqr. List by obs gp -At tp level, tasks can be 	<ul style="list-style-type: none"> - Determine total eqpt and tps reqr (i.e. reqr 6 tps and 4 AT ditching tms) to complete tasks within time limits - Phasing reqr? - Estb of pri of work - Shortfalls in pers, eqpt, and / or mines and expl (CI V) can be ident - Mod of design or elimination of some tgt sers to meet timings reqr? - Const sequence - Gpings

Ser	Factors	Deductions
(a)	(b)	(c)
	listed by tgt ser, or by sub-task (i.e. recce, setting out, fencing, laying, cache, tp har, protection)	
8	Crses open and selection of best crse	<p>- For a sqn-level engr est, the crses open to you relate more to gpings and con rather than to specific obs. The sqn comd may choose between org his sqn along functional (each tp performing one type of task), or geo lines (each tp is resp for all obs within a certain sector), or using a combination of the two methods. At the tp level, the crses open may relate to choices between a no of different obs types to accomplish the desired obs effect for the given obs grp (i.e. do you accomplish the TURN with three minefields, or with two minefields and an AT ditch?).</p> <p>- Crses open to the en would relate to various breaching methods or possible approaches (with us in the def), or to possible en obs designs (with us in the off).</p>
9	Outline Plan	<p>The outline plan is prep as per the tac est. A draft Obstacle Task Table (OTT) and/or obs resourcing table or sqn obs trace (giving obs gp) would also be incl in the COORD INSTRS sub-para.</p> <p>Similarly an obs gp exec matrix can be produced outlining the nec coord measures for obs emplacement in the BG area of ops.</p>

805.08 - FLOCARK

1. FLOCARK is a graphical method used to analyse the terrain as it relates to mil ops. The seven step method is described by the mnemonic FLOCARK (Features, Lanes, Objs, Canalizing grd, Approaches, Rate, and Key terrain). Beginners may wish to use three overlays: Canalizing grd; Objs and Key terrain; and Approaches and rating. On the table below these overlays are referred to as overlays A, B, and C.
2. With experience pers will be able to adapt the process to suit their needs, and may find themselves making further adds to the traces, such as (for

example), noting significant water features which may also impede mov (i.e. streams, canals, irrigation ditches, etc).

Step	Term	Notes	Symbols	Colour	Overlay	Remarks
1	Features	Canalizing features along the FEBA		black	A	Features less than approx two km ² needs not be considered.
2	Lanes	Lanes between features on the FEBA		red or blue	A	Indicate the force size, which allows its use.
3	Objs	Obtained through templating, or given in orders.		red or blue	B	
4	Canalizing Grd	Inside, and bordering outside of the op area		black	A	
5	Approaches	All areas not considered canalizing grd		red or blue	C	
6	Rate	Adjust objs to relate to the terrain. Disposns and bdry can be guessed at. Ident approaches with ltrs and rate with nos (A4, B2, C1, D3).	"A" "B" "C" "D"	red or blue	C	Frontages: Div: 4-7 km Regt: 2 - 4 km Bn: 1 - 2 km Coy: 0.5 - 0.8 km Pl: 0.1 - 0.2 km
7	Key Terrain	KEY TERRAIN (KT) Vital Ground (VG)	KT # VG # KZ # LZ #	blue blue black red	B	There may be a few KT "goose eggs", but only one VG can be designated.

Step	Term	Notes	Symbols	Colour	Overlay	Remarks
		Killing Ground (KZ) Landing Zone (LZ)				

805.09 - ENGINEER ORDERS – EXECUTION PARAGRAPH

DEPLOYMENT TO A NEW AREA PRIOR TO BEGINNING AN ENGINEER TASK	MINEFIELD TASK
a. Gen Outline. Outline your intent and concept of ops, task, recce arrangements, prep and mov of har party, move of main body, prep for or rec from task, expected length of stay	a. Gen Outline. Outline your intent and concept of ops, tasks, setting out, minelaying party, sequence of laying, fencing party, TC, existence of lanes and/or gaps
b. Gpings and Tasks (1) Recce party (if moving to a task). Composition, timings, rte(s), task(s) (2) Har Recce Party. Composition, timings, rte(s), task(s) (3) Main Body. Action upon arr at new loc	b. Gpings and Tasks ² (1) Setting Out Party. comd, composn, detailed tasking(s) (2) Minelaying Party. Comd, gping, alloc of eqpt (3) Fencing Party. Comd, gping, alloc of eqpt (4) Comd, composn, detailed tasking(s) (5) Rte Closure Party. Comd, gping, alloc of eqpt, task(s)
c. Coord Instrs (1) Timings. H hr, NMB/mov of main body, recce departs (if depl to a task), time mov complete (2) Mov. rtes, SP, rel P, OOM (3) RV. Recce party, har recce party, main body, regping of engr eqpt att (4) Action on Contact. On rte, in new loc (5) Action on Mor/Avn/Arty/Air Atk (6) Pri of Work upon Arr at New Har. Siting vehs, siting sp wpns, def plan, digging, depl of elms to task site(s)	c. Coord Instrs (1) Timings. Cache open, setting out commences first mine in the grd, task complete (2) Minefield design. Type, coords and loc of mine row marking pickets, lanes (loc, con, marking), gaps (loc, con, and marking) (3) Rte Closure. Firing of dmls to close rtes (where, when, on whose auth), issue of DND 913 (where, when, to whom)

DEPLOYMENT TO A NEW AREA PRIOR TO BEGINNING AN ENGINEER TASK	MINEFIELD TASK
<p>(7) Cam and Concealment. (Specific dir on stages). Cam nets/hessian, TI screens, scrim, EMCON</p> <p>(8) Secur. Local def, lts/noise in har and at work site(s), sentries (NBC/air), manning of rv</p> <p>(9) NBC. MOPP levels</p>	<p>(4) Reporting and Recording. Resp for reporting to Tp HQ and SHQ, who will complete minefld record, who is to sup info for completion</p> <p>(5) Mov. Rtes to/from caches, rtes in/out of minefield, check pts</p> <p>(6) Action on Contact. In minefield, on rtes, in cache</p> <p>(7) Action on Mor/Avn/Arty/Air Atk</p> <p>(8) Ln. Locs of units covering the minefield</p> <p>(9) Secur. Local def, lts/noise on site</p> <p>(10) NBC. MOPP levels</p>
DML TASK	MINEFIELD BREACHING TASK
<p>a. Gen Outline. Outline your intent and concept of ops, task, prelim or res, CMs, alloc of sects to tasks, method of atk</p>	<p>a. Gen Outline. Outline your intent and concept of ops, tasks, no of lanes to be attempted, method of breaching, res, and link to the tac plan</p>
<p>b. Gpings and Tasks. The fol must be detailed:</p> <p>(1) charge prep party;</p> <p>(2) charge placement party;</p> <p>(3) firing circuit prep party;</p> <p>(4) firing pt prep party;</p> <p>(5) firing party; and</p> <p>(6) mining party</p>	<p>b. Gpings and Tasks. The fol must be detailed:</p> <p>(1) Mech/expl Breach: breaching site comds, lane comds, res, lane marking, and lane improvement/main, TC</p> <p>(2) Hand breach: recce party, setting-out party, breaching party, pulling or expl charge party, lane marking, and lane improvement, TC</p>
<p>c. Coord Instrs</p> <p>(1) Timings. Expl aval, NMB, start work, State 1/2, task complete</p> <p>(2) Method of Atk. Detailed design</p> <p>(3) Con of Dml. Issue of DND 913 (when, where, to whom), auth</p>	<p>c. Coord Instrs</p> <p>(1) Timings. NMB before, setting out, H hr, breach completed first veh through the minefield</p> <p>(2) Breach Design. No of lanes attempted, method of selecting lanes to be used, initial marking system (minetape, chem lts, wire),</p>

DEPLOYMENT TO A NEW AREA PRIOR TO BEGINNING AN ENGINEER TASK	MINEFIELD TASK
<p>to fire dml</p> <p>(4) Mov. Rtes to/from site, OOM</p> <p>(5) TC. Stopping tfc and refugees before firing, protection of dml from interference</p> <p>(6) Action on Contact. On rte, on site</p> <p>(7) Action on Mor/Avn/Arty/Air Atk</p> <p>(8) Reporting and Recording. Changes in dml state, results</p> <p>(9) Ln. With dml gd (if provided), with friendly forces covering the obs</p> <p>(10) Safety. Sig used when firing, life jackets over water</p> <p>(11) Secur. Local def (NBC, air, water sentries), Its and noise on site</p> <p>(12) NBC. MOPP levels</p>	<p>alloc of ress for lane improvement and NATO std marking, dir of travel through the lanes</p> <p>(3) RV. Regping prior to task (plough tks, etc) - where, when</p> <p>(4) Action on Contact. In minef, on rte</p> <p>(5) Action on Mor/Avn/Arty/Air At.</p> <p>(6) Action on Lane Closure by the En</p> <p>(7) Ln. With force in place, brhd force</p> <p>(8) Secur. Local def, Its/noise on site</p> <p>(9)NBC. MOPP levels</p>
BRIDGING TASK	
<p>a. Gen Outline. State your intent and concept of ops, day/ni build, and bldg tps. Outline in gen terms sect activities (for mov and build)</p>	<p>(5) Secur. Local def, Its/noise in har and at work site(s), sentries (NBC/air), aval of protection from other units in local area (if aval)</p>
<p>b. Gpings and Tasks. The fol must be detailed:</p> <p>(1) Tp WO;</p> <p>(2) Recce Sgt;</p> <p>(3) all sects;</p> <p>(4) br train storeman; and</p> <p>(5) trkway laying op</p>	<p>(6) TC. Start of tp resp, method of con</p>
<p>c. Coord Instrs</p> <p>(1) Timings. Depart, const to begin, br open NLT</p>	<p>(7) Defile Marking. Details, resp</p>
<p>(2) Mov. Rtes, OOM (recce gp with br train, tp to new har loc)</p>	<p>(8) Const Sequence. (i.e.) Drop pallets, TLARS, etc...</p>
<p>(3) Action on contact. On rte to site, on site.</p>	<p>(9) Br Maint During Crossings. Eqpt aval, methods, resp</p>
<p>(4) Locs. New tp har, const site, waiting area, marshalling area</p>	<p>(10) NBC. MOPP levels</p>

DEPLOYMENT TO A NEW AREA PRIOR TO BEGINNING AN ENGINEER TASK	MINEFIELD TASK
NOTES:	
1. Orders for cbt tm ops may be found in the TAM 108.	
2. Integrity of tps and sects should be maint wherever possible.	

805.10 - BRIEFINGS

1. An important skill to acquire is the ability to properly brief. There are a no of different types of briefings, each intended for a different purpose. Possible formats incl: the CP/DO handover brief, the sit brief, the int brief, the briefing of an est or plan, and the grd brief.
2. There are a no of gen rules to be fol regardless of the specific type of brief being presented. These rules incl:
 - a. christen the grd properly, and ensure that nothing is left out. Know the area that you are briefing - you should not have to look closely at the map to find a point that you are talking about;
 - b. present your mat in a logical sequence;
 - c. tailor your briefing to your audience, and avoid repeating info that is "common knowledge";
 - d. respect any timings that you have been given (i.e. if you are given five min to brief, do not take 10);
 - e. rehearse or mentally prep your brief;
 - f. make notes. Cue cards are ideally suited for this. No your cards; and
 - g. anything mentioned in the briefing of the sit should have been pt out in the christening of the grd.
3. **Christening the Grd in a CP (From a Map):**
 - a. use a logical sequence i.e. LEFT to RIGHT, NORTH to SOUTH);
 - b. start by pt out geo features (mountains, riv, canals, lakes, valleys);
 - c. mov on to man-made features (cities, towns, rd networks, br and rlyl lines, large power lines, etc);
 - d. ident key features which would come up in the body of your tac brief (i.e. if you are using a small town as the site for the sqn HQ loc, pt it out during the christening of the grd). Nothing that is mentioned during the orders should be overlooked in the christening unless everyone is already familiar with it;
 - e. where con features are related to a piece of terrain (i.e. a handover line based on a hwy), pt out the physical feature during the christening of the grd; and
 - f. unless you are briefing from a sketch, or the conventions for map making have been radically altered, there is no reqr to indicate that NORTH is at the top of the map.

4. **Christening the Grd at the Task Site:**
 - a. find a good loc where the best pt of obsn can be reached (taking into account the tac sit), and arrange the pers recv the brief so that they can see you and the grd;
 - b. orient your map to the grd, pt out NORTH, give the GR where you are presently loc, and pt it out on the map;
 - c. from this pt on use the map sparingly; you have the best possible briefing aide in front of you - the actual grd you will be working on;
 - d. use the map to pt out various features which might have tac significance (i.e. that rd 300 m to your front that is the handover line between the Div Recce Regt and the Bde Recce Sqn); and
 - e. use proper tgt indication tech to ensure that the people you are briefing are seeing what you are trying to pt out.
5. **The DO Handover Brief.** The sequence of the DO handover brief is as fol:
 - a. En:
 - (1) units in contact;
 - (2) activity which can affect the local sit;
 - (3) other activity; and
 - (4) conclusions covering crses of action open to the en.
 - b. Own Sit
 - (1) loc of fwd elms;
 - (2) loc of units, HQ and bdrys;
 - (3) str or effectiveness "two down" of units under comd;
 - (4) brief description and results of ops during the pd of report;
 - (5) impending movs or regp; and
 - (6) conclusions incl suggested crses of action within comd's intentions and dir.
6. **The Sit Brief.** The aim of the sit brief is to update the comd (or mbrs of his staff). The info should be presented in a meaningful, concise manner. DO may be given little or no adv wng of the reqr to brief.
7. The format to be fol is:
 - a. state the time pd covered by the briefing;
 - b. start with any info (three pts is the max) of extreme importance to the comd. If the briefing is interrupted or the comd is called away, he will still have the most important info aval to him;
 - c. present the events from LEFT to RIGHT and FRONT to REAR through the are of resp (e.g. from covering force to the res). Give current locs, dispositions, tasks and activities of units, en locs and activities. Then deal with the flanks in the same manner; and
 - d. incl any other pts of current interest, incl maj problems of empl or deployment, atts and dets, air activity, admin problems, etc.
8. If info or int from higher HQ is mentioned, ident the source and state whether the info is factual or the result of a deduction. Neg info is often important, and should be mentioned when applic. When relating an event to the map, pin-pt the loc referred to and give the time of the event.

9. **Briefing the problem before presenting the est and/or the plan:**
- christen the grd (incl any con measures that are related to a feature on the grd);
 - outline the bdrys of your fmn and ident the flanking units;
 - discuss the depl of the fmn (i.e. the bde is def two bns fwd, with one bn in depth);
 - discuss the en - where is he, in what str, and what do we expect him to do;
 - brief the comd intent (remember Intent - Purpose - End State);
 - state the problem to be answered (i.e. the problem given to me was to prep an est for the CS Sqn sp the RCD BG in the def; and
 - present the est or the outline plan as reqr, starting with your msn analysis.

805.11 - ENGINEER RECONNAISSANCE – GENERAL

1. **Tips for Conduct of Recce:**

- always dir recce effort towards msn. If time is limited, pri recce tasks and select rtes accordingly;
- detail a list of ques to be answered/decisions to be made during recce;
- make max use of hels and air photos; and
- conduct a thorough map est before departure, and be ready to cfm pts that had come up while you reviewed the map.

RECCE PLAN CONSIDERATIONS			
a. Aim of Recce.		e. Eqpt reqr.	
b. Time Aval: (1) recce report to be completed by; and (2) report submitted to whom.		f. Suitable vantage pts.	
c. Restrictions. Daylight recce, rtes, specific timings.		g. Pri sites to be visited.	
d. Secur - loc protection aval.			
STD RECCE CHECKLIST			
a. Assorted stationary incl recce proforma.	d. Mine detector and prodders.	g. Recce Boat.	j. Compass.
b. Maps: (1) gen maps of the area, (2) rd and br maps; and (3) cross country mov maps.	e. Tools: (1) pliers; (2) wire cutters; (3) pick; (4) shovel; and (5) axe	h. Engr Recce Suite: (1) computer; (1) (2) laser binoculars; (2) (3) digital camera; and (3) (4) GPS.	k. Measuring Tapes: (1) 30 m tape, (2) two 3 m tape, and (3) ball of string.

c. Two rolls of mine marking tape.	f. Two flashlt.	i. Camera Polaroid	l. 12 wooden stakes and chalk.
ENGR RECCE CHECKLIST			
a. Rds. Classify all rds in and out of task site.	g. Barriers to En Mov. Describe natural or artificial barriers and sites for const or improvement complete with work ests.	l. Const Sites. Report drainage, WS, power sup, earthwork, eqpt being used, access, acreage, and soil conditions.	
b. Brs, Fords, and Ferries. Classify all within the area of tasking incl possible bypass for existing crossings.	h. Streams. Give a gen decription of width, depth, banks, approaches, character of bottom, navigability, and possible crossing sites.	m. Any other info of importance.	
c. Obs to Mov. Report all natural and artificial obs incl dmls, mines, and booby traps.	i. Def Posns.	n. Engr Eqpt. Record data on rock crushers, sawmills, garages, machine shops, blacksmith shops, or any other facilities or eqpt	
d. Terrain. Report gen nature, ridge system, drainage system incl fordability, forests, swamps, and areas suitable for mech ops.	j. Bivouac Areas. Give details on entrances, soil, drainage, sanitation, and concealment.	o. Util. Give details on water, sewage, elec, and gas util aval.	
e. Engr Mats. Report rd mat, br timbers, lumber, steel, and expls.	k. POL Storage and Eqpt. Give details on what eqpt and how much storage.	p. Ports. Give details on wharves, sunken obs, cargo handling facilities, storage facilities, and tpt rte.	
f. WP. Recommend locs.			

MOBILITY SP

805.12 - ROUTE RECONNAISSANCE

1. The purpose of the recce must be clear. There are two types of rte recce tasks:

TAC RECCE	TECH RECCE
<p>a. This may be limited to:</p> <ul style="list-style-type: none"> (1) Width (one way/two way with difficulty, etc.), (2) Surface in terms of trafficability having regard to weather at the time, and <p>b. Ld capacity (normally governed by br MLC).</p> <p>b. However, the fol add info may be reqr:</p> <ul style="list-style-type: none"> (1) Loc and extent of damage by en action, (2) Loc and probable extent of mined areas, (3) Visibility from en posns, (4) Critical pts, (5) Temp br or crossing sites, (6) Locs of aval ress, and (7) Essential rep work. 	<p>a. The purpose may be to:</p> <ul style="list-style-type: none"> (1) Assess the capability of an existing rd, (2) Determine the improvements reqr to bring it to a particular std, and (3) Prep a rd denial prog.

2. **Reports.** The fol reports should be used to report rte recce info by rad/data (voice templates for these report are incl in this TAM under Reps and Rtns. Data formats are include in Engineering Command and Control (ECCO):

NAME OF REPORT	NAME OF REPORT
E110A Rte Recce Order	E111A Rd, Br and Tunnel Recce Order
E110B Rte Recce Report	E111B Rd, Br and Tunnel Recce Report

3. **NATO System.** Utilizing the rte recce info, the NATO system is used to classify the rte. The NATO system has two parts: rte and rd classification.

a. **Rte Cl.** This is the overall cl of the rte and consists of four elms:

(1) Min width of rd (m)	(3) MLC of the rte, defined by its weakest pt or sect
(2) Type: X = All weather; Y = Limited all weather; Z = Fair weather	(4) Restrictions if any
(5) Example: 10.5/X/60/4 refers to an all weather, Cl 60 rte, rd width 10.5m with a height restriction of 4m	

b. **Rd Cl.** Each sect of rd is classified using a six-part formula. The elms of the formula are described at para 4.

(1) Example. B g s (f?)3m/5/ r (6.2km)(W) denotes a rd with limiting factors, steep gradients, rough surfaces, doubtful foundations, 3m travelled way/5m across shoulders, stabalized, crushed rock or coral, 6.2m long and subj to flooding.

- c. **Brs.** Data on brs is recorded on a trace using the symbols described below.
- d. **Obstructions.** Obstructions are indicated by adding "(Ob)" to the rd formula. Details are recorded using the symbols described at para 4. The fol normally constitutes an obstruction:
- (1) overhead clearance less than 4.25m;
 - (2) reductions in rd widths which limit tfc capacity e.g. craters;
 - (3) gradients of 7 % and over;
 - (4) curves with less than a 30m radius; and
 - (5) fords and ferries.
- e. **Recording.** Data should be recorded during the recce on a trace (example below). If recce data is fwd by rad/data utilizing reports at para 2 then a trace is fwd separately.
- f. **NATO Route Report.** Rte cl reports are made in the format below which may also be used for other tech reports.

<p>NATO ROUTE REPORT</p> <p>To (HQ ordering recce)</p> <p>From (Rank, name, unit)</p> <p>Maps No (Country, scale, sheet)</p> <p>DTG (Of signature)</p>	
<p>GEN INFO</p> <p>1. Rd:</p> <p>a. From to</p> <p>b. From to</p> <p>2. Rd Marking (Civ or military)</p> <p>4. DTG of recce</p>	<p>Notes for sketch:</p> <ol style="list-style-type: none"> 1. Record the scale, and GRs of important pts. 2. Use the symbols described below to record features in their correct locs, adding GR if nec. The side of the loc may record other facts.
<p>5. NATO Rte Cl</p>	
<p>6. Rd Formula</p>	
<p>7. Shoulders (type and whether usable in an emergency)</p>	





8. Obstructions:				
Ser	Particulars	GR	Rd Sect	Remark
9. Encl (Overlays, maps, sketches, etc)				
Signature				

4. Symbols for Road Classification Formula

SER	ELM OF FORMULA	SYMBOL	MEANING
(a)	(b)	(c)	(d)
1	Prefix	A B	No limiting factors One or more limiting factors
2	Limiting factors:		
a	sharp curves	'c'	Radius less than 25 m
b	steep gradients	'g'	Gradients of seven percent or over
c	poor drainage	'd'	Inadequate or blocked drainage
d	weak foundations	'f'	Unstable, loose or easily displaced
e	rough surface	's'	Likely to reduce convoy speed
f	excessive camber superelevation	'j'	Likely to cause hy veh to slide or drag toward rdside
g	doubtful conditions	?	Indeterminate or doubtful conditions expressed with ? and (), e.g. (f?)
h	shoulders	-	No symbol but written reports should specify
3	Width	?m/?m	Width travelled way/width including shoulders
4	Const mat:		
a	type X rte	'k'	Concrete
b	type X rte	'kb'	Bituminous or asphaltic concrete
c	type X rte	'p'	Paving brick or stone

SER	ELM OF FORMULA	SYMBOL	MEANING
(a)	(b)	(c)	(d)
d	type X rte or Y rte	'rb'	Bitumen penetrated macadam, waterbound macadam with superficial asphalt or tar cover
e	type Y rte	'r'	waterbound macadam, crushed rock or coral
f	type Y rte	'l'	Gravel
g	type Y or Z rte	'nb'	Bituminous surface tmt on natural earth, stabilised soil, sand-clay etc.
h	type Z rte	'n'	Natural earth stabilised soil, sand-clay, shell, cinders etc
i		'b'	Bituminous const. To be used alone only when type of bituminous const cannot be determined
j		'v'	Various other types not mentioned above
5	Length	(?2km)	Length of sect may be added if desired
6a	Obstructions	(Ob)	Symbol at end of formula indicates existence
b	Snow	(T)	Reg, recurrent and serious snow blockage
c	Flooding	(W)	Reg flooding which impedes t/c

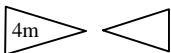
5. Rte Recce Conventional Signs

25m 	Sharp curve(radius in ft or m)
>14% 10-12% 7-10% 	Steep grade, arrows pt up hill, grade in percent (length of arrows may show length of grade when scale allows)
	Constriction (width in ft or m)
	Arch constriction (width [left] and height [right] in ft or m)

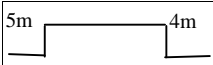
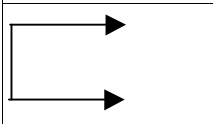
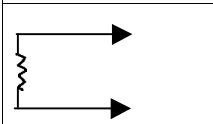
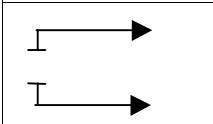
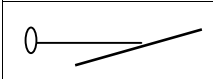
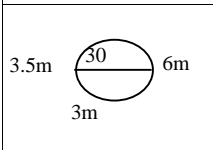
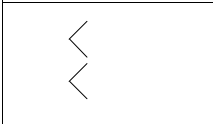
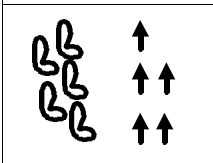
	Underpass constriction (width [left] and height [right] in ft or m)
	Bypass – easy
	Bypass – difficult
	Bypass – impossible
	Level crossing
	Br cl (top segment) overhead clearance [left] width [underneath] length [right]
	Limit of sector
(B2019)	Civ or Military Rte Design Notation
	Cover (deciduous [left] evergreen [right])

	Cover (woods)(deciduous [left] evergreen [right]). Arrow denotes possibility of driving off the rd
	Ferry. Type and seasonal limitations [top]. Capacity [centre]. Crossing width [bottom] A= Automobile P = Pax
	Ford. Current vel m/s and seasonal limitations [top]. Width. Nature of bottom. Depth [bottom]. Approach easy [left]. Exit difficulty [right]

805.13 - ROAD STANDARDS

1. Rd Widths for Gen Purpose Rds

SER	SPECIFICATION	NORMAL TFC (m)	TRKS FOR LT VEH (m) (1)
1	Single Tfc Lane:(2) a. absolute min b. desirable min	3.0 (3) 3.7 (3)	1.8 2.5
2	Double Tfc Lane a. absolute min b. desirable min	6.0 7.3	3.6 4.7

NOTES:

- 4x4 veh up to 1/2 t ld carrying capacity.
- Passing places should be provided not more than 400 m apart.
- Tks reqr a min width of 4.5 m.

2. Limiting Gradients

Ser	Cl Of Gradient	Normal Country	Mountainous Country		
			Normal Tfc	Tk Transporter	Lt Veh(1)
(a)	(b)	(c)	(d)	(e)	(f)
1	Ruling	1 In 30	1 In 15	1 In 25	1 In 6
2	Max	1 In 15	1 In 10	1 In 15	1 In 4

NOTE: 1. 4x4 veh up to 1/2 t ld carrying capacity.

3. Comparative Gradients

Ser	Tangent	Percent	Angle Of Slope		Rise in m per km
			Degrees And Min	mils	
(a)	(b)	(c)	(d)	(e)	(f)
1	One in				

Ser	Tangent	Percent	Angle Of Slope		Rise in m per km	
			Degrees And Min	mils		
(a)	(b)	(c)	(d)		(e)	(f)
2	1	100.0	45	0	800	---
3	2	50.0	26	34	472	500
4	3	33.3	18	26	328	333
5	4	25.0	14	2	249	250
6	5	20.0	11	181/2	201	200
7	6	16.7	9	28	168	167
8	7	14.3	8	8	145	143
9	8	12.5	7	71/2	127	125
10	9	11.1	6	201/2	113	111
11	10	10.0	5	43	102	100
12	12	8.3	4	46	85	83
13	15	6.7	3	49	68	67
14	18	5.6	3	11	57	56
15	20	5.0	2	511/2	51	50
16	25	4.0	2	171/2	41	40
17	30	3.3	1	541/2	34	33
18	40	2.5	1	26	25	25
19	60	1.7	0	571/4	17	17
20	80	1.3	0	43	13	13
21	100	1.0	0	341/2	10	10
22	150	0.7	0	23	7	7
	200	0.5	0	171/2	5	5

805.14 - DRAINAGE

- Gen.** The aim of drainage is to keep the subgrade dry and to prevent the retention of water on the rd.
- Discharge Calculations.** Discharge is calculated by the fol formula:

$$Q = \frac{2.8}{10^7} \times \frac{ARI}{f}$$

R = run off factor

F = slope factor

Where

Q = discharge in m³/sec

A = catchment area in m²

I = rainfall intensity determined as 4% of annual rainfall in 25cm or more, or 8% of annual rainfall less than 25cm

RUN OFF FACTORS			SLOPE FACTORS		
Ser	Type Of Surface	Value of R	Ser	Avg Slope of Surface	Value of f
(a)	(b)	(c)	(a)	(b)	(c)
1	Asphalt pavements	0.80 – 0.95	1	1 in 200 or less	3.0

RUN OFF FACTORS			SLOPE FACTORS		
Ser	Type Of Surface	Value of R	Ser	Avg Slope of Surface	Value of f
2	Concrete pavements	0.70 – 0.90	2	Between 1 in 200 and 1 in 100	2.5
3	Gravel and macadam pavements	0.35 – 0.70	3	1 in 100 or more	2.0
4	Impervious soils	0.40 – 0.70			
5	Impervious soils with turf	0.35 – 0.60			
6	Pervious soils	0.10 – 0.45			
7	Pervious soils with turf	0.05 – 0.30			
<p>NOTE: Values are for flat areas up to 1:50 slope. For ea degree or 2% above 1:50 add 0.1 to figures to a max of 1.0.</p>					

3. **Ditch Size.** The cross sectional area of a ditch to tpt a given run off is calculated from:

$a = \frac{Q}{v}$ <p>Where a = area in m²</p>	<p>Q = discharge in m³/sec v = max permissible vel to prevent scour of particular soil in m/sec</p>
--	--

MAX PERMISSIBLE VELOCITY (v)		
Ser	Nature of Soil	Max Permissible Vel (v) in m/sec
1	Uniformly graded sand and uncohesive silt	0.30
2	Well graded silt	0.45 – 0.75
3	Silty sand	0.6 – 0.9
4	Clay	0.9 – 1.2
5	Coarse gravel or cobbles or soil with protection against scour by turf or other means	1.4 – 1.8

4. **Culvert Size and Positioning.** The total cross sectional area of culvert reqr to carry the discharge from a given ditch can be estimated as twice the cross sectional area of the ditch (up to the high water mark). The outfall of culverts should extend 0.6m beyond rd embankments. Max cover over culverts is 0.3m or one-half the culvert dia, whichever is larger. On gradients, ditch relief culverts should be spaced as fol: 1:12 slope – 100m, and 1:20 slope – 200m.

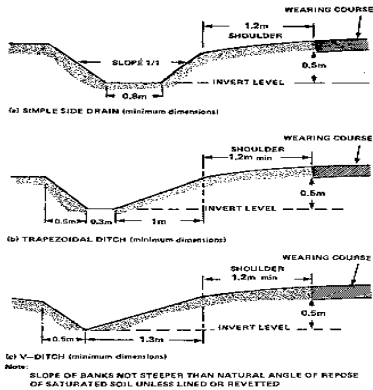

5. Culvert Details

SER	TYPES	SIZES	CONSTRUCTION	REMARKS
(a)	(b)	(c)	(d)	(e)
1	Pipe culverts-ARMCO	0.20 m 0.30 m 0.45 m 0.61 m 0.76 m 0.91 m 1.52 m 2.13 m	Lap joints, staggered top and bottom. No concrete reqr.	Usual sizes aval: 0.20 m and 0.30 m.
2	Concrete tubes	Up to 1.82 m dia	Open joint. Concrete bed and surround desirable.	
3	Drums 182 1	Approx 0.61 m dia	Surround nec for protection (0.15 m concrete preferable).	Improvisatio n.Ends cut out of bitumen or fuel drums.
4	Stoneware	Up to 0.61 m dia	Spigot and socket joint. Over 0.45 m dia bedded in concrete. Min cover: 0.61 m.	Pipes with over 6.10 m or under 0.91 m cover surrounded by 0.15 m concrete.
5	CI pipes	Up to 1.22 m dia	Cement mortar jointing. Concrete bed not nec.	Strong. Suitable where cover is small.

805.15 - SURFACE EXPEDIENTS AND TRACKWAY

1. Corduroy Rd/Plank or Slab Rd.

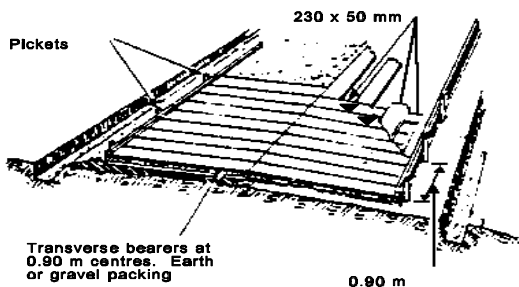
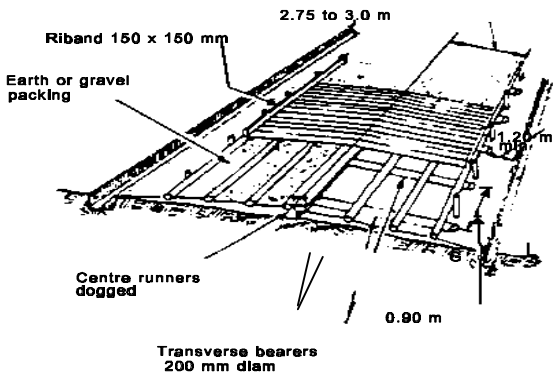

2. Snow and Ice Rds

LD CAPACITY FOR ICE		
Ice Thickness (cm)	Capacity	Max Spacing
3.8	Indiv soldier	20 paces
5.1	Indiv soldier	5 paces
10.2	Inf single file	20 m
20.3	MLVW empty, LSVW lded, or 4.t veh with max axle ld of 2.74 t	20 m
25.4 – 33	8 t veh fully lded, or MLVW lded	20 m
30.5 – 38.1	Total veh wt 10 t	20 m

LD CAPACITY FOR ICE		
Ice Thickness (cm)	Capacity	Max Spacing
35.6 – 45.7	Total veh wt 22 t or HLVW fully lded	20 m
50.8 – 91.4	Total veh wt 40 t	30.5 m

3. **Class 60 Trkwy**

CHARACTERISTICS	CARRIED ON CONVENTIONAL VEH/TLR	CARRIED ON TRKWY LAUNCH AND REC SYSTEM (Tlars)
Dimensions of roll	15 m long, 4.6 m wide	50 m long, 4.6 m wide
Wt	Roll - 2.4 t	Trl + 50 m of trkwy - 15.2 t
Laying rate (1)	From tlr: 4 pers - 5 min By hand: NCO+10 pers - 30 min	3 pers - 5 min
Rec rate (1)	FEL and NCO+10 pers - 30-40 min	3 pers - 15-20 min (2)
NOTES: 1. Double timings at ni. 2. Max of 25 m can be lifted using manual override.		

805.16 - ROAD REPAIRS

1. **Rep to potholes:**

- where possible, trim the hole square or rectangular with the edges neither parallel nor at right angles to the t/c flow, leaving the sides vertical and firm;
- remove all loose mat and water;
- refill with dry, hard mat (eg. 50 mm graded stone or bitumen), in 75 mm layers, compacting each layer by ramming; and
- finish off with a layer of smaller gauge mat watered and rammed. Leave the finished surface slightly proud.

2. **Rep to Small Craters:**

- cut the hole square and remove all loose mat and water;
- refill with 150 mm layers of rammed hardcore, or soil in sandbags alternating with 150 mm of well rammed earth (see below); and
- finish off as for a pothole.

805.17 - SAFE ANGLE OF REPOSE AND SAFE BEARING PRESSURE

SER	TYPE OF GRD	SAFE ANGLE OF REPOSE	SAFE BEARING PRESSURE (kPa)
(a)	(b)	(c)	(d)
1	Rock (Solid)	65°	800 To 2000
2	Chalk	45°	500 To 700

SER	TYPE OF GRD	SAFE ANGLE OF REPOSE	SAFE BEARING PRESSURE (kPa)
(a)	(b)	(c)	(d)
3	Gravel And Sand	30°	200 To 400
4	Sand And Clay	15°	50 To 200

805.18 - FIELD MACHINES AND RIGGING

1. Str of Ropes, Blocks and Shackles

SER	PURPOSE	FORMULA (1)
(a)	(b)	(c)
	Cordage	
1	Wt of natural fibre rope	$d^2/15$ kg per 100 m
2	Wt of man-made fibre rope:	
	A. Floating rope	$d^2/20$ kg per 100 m
	B. Non-floating rope	$d^2/15$ kg per 100 m
3	SWL of natural fibre rope in good condition (2)	$d^2/1000$ T
4	Str factor relative to natural fibre rope:	1.0
	Grade 1 manila	2.5
	Polyamide	2.0
	Polyester	1.3
	Polyethylene	1.7
5	Polypropylene	$0.4 d^2$ kg per 100 m
6	SWR Wt of SWR	$d^2/120$ T
7	Safe Working Load (SWL) when in good condition (3)	9d
8	Blocks, shackles and chains	18d
9	Dia of sheave of a block cordage dia d	$3.5 d^2/1000$ T
10	Dia of sheave of a block SWR dia d SWL on shackle pin, dia d SWL on chain link, metal dia d	$d^2/100$ T

NOTES:

1. dia(d) = dia in mm, t = tonnes.
2. Reduction factors in cordage:
 - a. Serviceable but not new 0.8
 - b. Knot or sharp bend 0.7
 - c. Uneven distr of stress 0.8
 - d. Water saturated natural fibre 0.7
3. Reduction factors in SWR:
 - a. Damaged but serviceable 0.6
 - b. Sharp bends 0.7
 - c. Uneven distr of stress 0.6
 - d. With double-throated clamps 0.95
 - e. With bulldog grips 0.75

2. **Safe Working Load on Blocks, in Tonnes**

SER	ROPE DIA (mm)	BLOCKS FOR MANILA AND HEMP ROPE			BLOCKS FOR STEEL WIRE ROPE		
		Snatch Block	Double Block	Treble Block	Snatch Block	Double Block	Treble Block
(a)	(b)	(c)	(d)	(e)	(f)	(g)	(h)
1	8	-	-	-	1.0	1.75	2.75
2	12	0.2	0.3	0.4	2.0	5.0	7.0
3	16	0.3	0.4	0.6	4.0	10.0	15.0
4	24	0.8	1.2	1.8	9.0	15.0	25.0
5	26	1.0	1.4	2.1	-	-	-
6	32	1.2	1.8	2.7	16.0	25.0	35.0
7	40	2.4	3.3	5.3	-	-	-

3. **Anchorage**

SER	TYPE OF ANCHORAGE	CAPACITY (kg)
1	Single picket	350
2	1-1 picket holdfast	700
3	1-1-1 picket holdfast	900
4	2-1 picket holdfast	1,000
5	3-2-1 picket holdfast	2,000
6	Ordnance pattern holdfast	1,000
7	Baulk held by 1-1 picket holdfast (per holdfast)	600
8	Baulk held by 2-1 picket holdfast (per holdfast)	900

NOTES:

1. Angle of pull less than 30° above grd.
2. All figs given are for normal earth. For other types of earth the capacity of the anchorage should be multiplied as fol:
 - a. Stiff clay (drained) by 0.9
 - b. Avg soil and sandy clay by 0.7
 - c. Loose sand, shingle, or soft clay by 0.5
3. Limiting factor of ordnance holdfast is the shackle – 6,000 kg

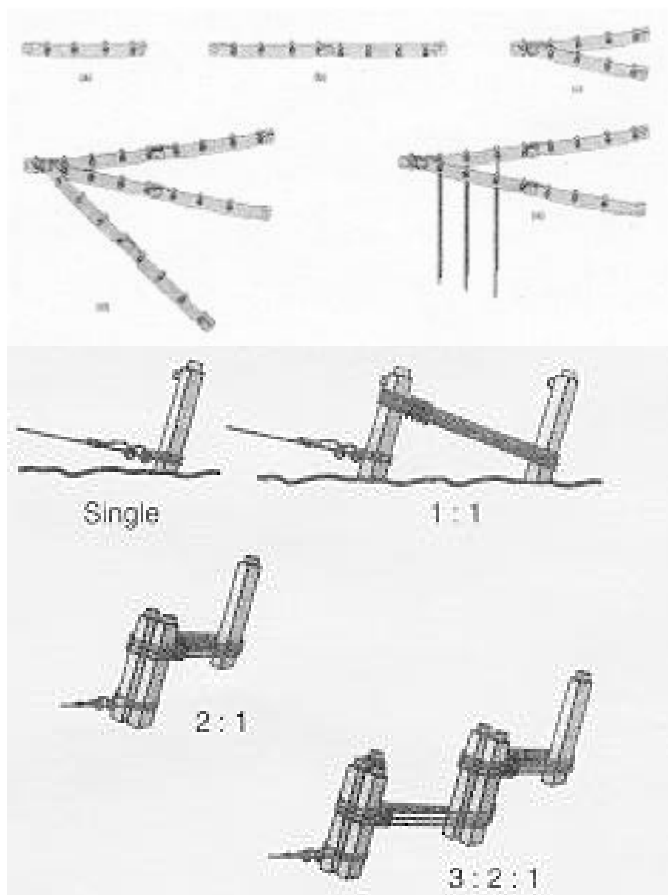

Ordinance Pattern Holdfast and Picket Pattern Holdfast

4. Fd Machines

a. Maximum load (kN) on spars of various lengths and diameters

SER	SPAR MEAN DIAMETER (mm)	EFFECTIVE LENGTH OF SPAR (m)															
		3	4	5	6	7	8	9	10	11	12	13	14	15	16	17	18
(a)	(b)	(c)	(d)	(e)	(f)	(g)	(h)	(j)	(k)	(l)	(m)	(n)	(p)	(q)	(r)	(s)	(t)
1	150	39.6	24.5	15.6	10.7												
2	175	67.6	45.	28.4	19.6	4.7											
3	200	99.8	65.8	47.0	33.3	24.5	19.6										
4	225	138.1	106.8	76.4	54.8	42.1	31.3	24.5									
5	250	180.4	147.0	109.7	81.3	61.7	46.0	37.2	30.3								
6	275	228.3	194	154.8	119.5	88.2	66.6	55.8	48.0	37.2							
7	300	278.3	246.9	205.8	158.7	126.4	98.0	79.3	69.5	53.9	44.1						
8	325	338.1	300.8	256.7	208.7	170.5	133.2	107.8	85.2	74.4	58.8	51.9					
9	350	396.9	362.6	231.2	267.5	215.6	176.4	141.1	118.6	98.9	81.3	68.6	59.7				
10	375	460.6	431.2	386.1	332.2	277.3	227.3	182.2	153.8	128.3	108.7	89.1	79.3	68.6			
11	400		495.8	450.8	399.8	343.0	281.2	242.0	191.1	163.6	140.1	117.6	99.9	90.1	78.4		
12	425				471.3	420.4	355.7	292.0	247.9	202.8	177.3	151.9	126.4	113.6	100.9	89.1	
13	450					498.8	428.2	364.5	305.7	256.7	220.5	192.0	163.6	142.1	127.4	113.6	98.9

NOTES:

1. Effective length means unsupported length, e.g. between restraining guys and foot ropes.
2. Effective length divided by the diameter must not be greater than 40.
3. Assumes SC3 timber.

b. Spar Diams for Elevated Cableways and Gyns

SER	TENSION (T) (kg)	TENSION IN LEG (T/5) (kg)	MIN DIA OF SPARS FOR GYN (mm)					
			Effective Length (m)					
			4.5	6	7.6	9.0	10.7	12.2
(a)	(b)	(c)	(d)	(e)	(f)	(g)	(h)	(i)
1	500	100	76	102	127	140	165	190
2	1000	200	89	114	127	152	165	190
3	2800	5600	102	127	140	165	178	203
4	4200	8400	114	140	152	178	190	216
5	6400	12500	127	152	165	190	203	229

NOTE: Colm (b) and (c) should be multiplied by 9.8m/sec^2 to obtain Newtons (N)

c. Safe Concentrated Lds on Suspended Cables

SER	DIA OF SWR (mm)	TENSION ON CABLE (kg)	SWL ON CABLE (kg)					
			Span (m)					
			50	100	150	200	250	300
(a)	(b)	(c)	(d)	(e)	(f)	(g)	(h)	(i)
1	8	0.55	90	80	75	70	65	65
2	12	1.20	200	185	170	160	150	135
3	16	2.10	350	330	310	285	265	240
4	20	3.30	550	515	480	445	410	375
5	24	4.70	790	720	690	640	590	540

NOTES:

1. Colm (b) and (c) should be multiplied by 9.8m/sec^2 to obtain Newtons (N)
2. Difference in level of the cable supports should not be greater than 1/25 of span.
3. The cable is assumed to be tensioned so that unloaded, the sag is 1/50 of the span. The sag with the load at the centre will be approximately 1/20 of the span.
4. Lds shown include safety factor of 6. Concentrated ld must incl wt of travellers and slings and an allowance of 10% for impact and wind.

805.19 - GAP CROSSING RECONNAISSANCE CHECKLIST

a. Eqpt and hy eqpt reqr (1) What (2) Why (3) When (4) Where (5) How long reqr	d. Marshalling Area (1-15 km from site) (1) Loc. In/out rte (width, cl, surface) (2) Size of area (3) Cam/concealment (4) Primary and altn rte (5) Capacity (6) Restrictions (7) Drainage (8) Veh spacing	g. Home and far banks (1) Crossfall/bank heights SAR (2) Grd bearing capacity (3) Type of soil/drainage (4) Obstructions (5) Anchorages	i. Approaches Existing (1) Surface (2) Wh rte (3) Slope (4) Trk rte (5) Drainage (6) Rd width
--	--	--	--

b. Engr ress (1) What (2) Condition (3) Qty (4) Where (5) Type (6) Size	e. Const site (1) Size (2) Stores area (3) Aval cover (grd andair) (4) Vegetation (5) Natural anchorages (6) Type of grd (drainage and trafficability) (7) In/out rte for br train (incl turn arounds, obstructions) (8) Prep reqr (lab/eqpt/ress/time)	h. Gap (1) Vegetation (2) River tfc/boat clearance (3) Slope to water (4) Nature of bottom (pier placement) (5) Water depth (6) Dams/ obstructions/ debris (7) Current vel	j. Approaches To Be Constructed (1) MLC (2) Maint reqr (3) Restrictions (4) Distance to access rte (5) Width/turn arounds (6) Alignment of approaches
c. WA. Between WA and site	f. Miscellaneous Data (1) Met conditions (present/forecast) (2) Hel landing pts (3) Existing facilities in area (gravel pits, power/fuel pumping sta, rail/dock facilities)		k. Access Rtes. As above, plus critical pts/brs on rte (MLC, width and height restrictions) TC reqr
NOTE: In add to all relevant info from above a site sketch should incl grid ref, MLC or rte, distance to WA, and loc of site HQ/TP CP.			

805.20 - ARMoured VEHICLE LAUNCHED BRIDGING

1. **Capability.** The length of the bridge of the armoured vehicle launch bridge (AVLB) is 22 m; however, the width of the gap that can be spanned in normal ops is 20 m, due to a reqr of a one metre SAR on either side. Where existing abutments or hardened bank seats are avail the SAR reqrs can be reduced to 0.5 m per side. The max vertical and lateral bank differences for the launch and rec is 10%, a difference of 2.2 m, thus sites with a gradient greater than these limits should be avoided due to the large amount of prep work reqr. The Leopard I AVLB Chassis is ident to that of the MBT however, the br is only of an aluminum alloy const and is much more easily damaged by dir or indir fire, collision or bending.

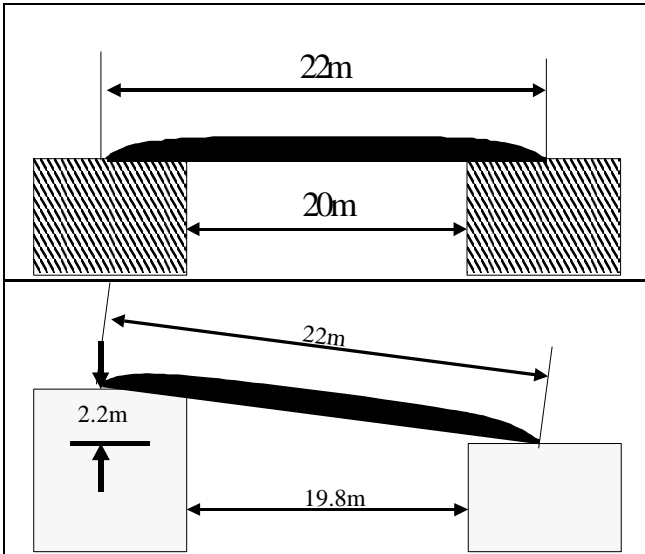

Max normal gap and max bankseat height difference

2. Recce

- Ensure that the gap is not more than 20 m;
- the launch grade or crossfall does not exceed 1:10;
- site is free from overhead obs;
- all sites should have straight approaches and exits to avoid trk veh turning on the approach or br; and
- consider the no of veh using the site.

3. **Launch Time.** Approx 2-3 min.

4. Laying Single Brs

- Anti-tank Ditch.** The end of br is to be 2/3 up on the berm.

- b. **Gaps Less Than 20 m.** With uneven heights, avoid step-ups and drop offs to prevent damage to the br, in this case prep the home side.
 - c. **Side Slopes and Uneven Bank Elevations.** Max lateral declination (sideslope), horizontal elevation (far bank is higher) or depression (far bank is lower) is 10%. An unsuccessful launch or damage to the br will occur if this is exceeded.
 - d. **Tunnels or Arches.** The 4 m width must be estb. A min 3.57 m above the roadway, curbs and handrails must fall outside this as well.
 - e. **Overbridging.** The clearance underneath the centre of the AVLB br must be 20 cm. The clearance between the top of the AVLB br and any overhead structure must be equal to or greater then the tallest veh to cross, the width between the curbs and/or handrails must be greater than 4 m for the br to fit, as well to allow for foot tfc. The gap of the br being overbr must also be less than or equal to 21 m. Wood packing must be used on all overbr. Small packing on the home side, large packing on the far side.
5. **Tandem Launch.** Tandem launch should not gen be const due to the complexity of the op and close tolerances that must be achieved. The fol must be considered when launching the br in tandem:
- a. **Prep measures.** A detailed recce of the obs must proceed the launch.
 - b. Att of a safety chains from the front jib to the br until br is anchored.
 - c. Four overlap sp blocks (packing) shall be provided as sp for the sp blade of the second and third AVLB.
 - d. Two 5X20X100 cm wooden planks to serve as sp for the ramp end of next br.
 - e. There is a reqr for guides and parties for the assembling of the mat for the const of an on shore anchor if the brs are to be laid into water whose current vel reqr such measures.
 - f. **Single Overlap:** The first br is launched is the std manner, and secur by means of retaining chains. Prior to the second br being launched onto the first br, two sp planks must be carried onto the first br and placed at the marked overlap.
 - g. **Double Overlap:** The third br is depl the same as the second br.
 - h. **Limiting Values:**
 - (1) The first br may be lowered into an obs with a max depth of 4.5.m, however the depth must not exceed:
 - (a) in still waters – 2.5.m, and
 - (b) in flowing water: greater than 1.5.m for currents up to 1.9 m/s or greater than 2.5.m for currents up to 1.7 m/s
 - (2) Max immersion depths for launched brs in flowing waters are as fol:

Area Exposed To Current	Current Vel	Ref Pt
¼ of Br	1.9 m/s	Third Shackle Bracket
½ of Br	1.7 m/s	Center Of Br

i. **Area Exposed to Current.** Brs launched in tandem in flowing waters shall be anchored if:

- (1) more than ¼ of the br is immersed and the current vel exceeds 1.0 m/s, and
- (2) less than ¼ of the br is immersed and the current vel exceeds 1.5 m/s.

805.21 - MEDIUM GIRDER BRIGING (MGB)

1. MGB Ld Class, No of Bays and Length

SER	MLC	SINGLE SPAN					
		Single Storey		Double Storey		Double Storey LRS (2)	
		Max length (m)	No of bays	Max length (m)	No of bays (1)	Max length (m)	No of bays
(a)	(b)	(c)	(d)	(e)	(f)	(g)	(h)
1	100(W)	9.8	5	27.4	10	31.1	12
2	70(T)	9.8	5	31.1	12	45.7	20
3	60(T)	-	-	32.9	13	-	-
4	60	9.8	5	31.1	12	49.4	22
4	50	9.8	5	34.8	14	-	-
5	40	13.4	7	38.4	16	-	-
6	30	15.2	8	42.1	18	-	-
7	24	17.1	9	45.7	20	-	-
8	20	18.9	10	47.6	21	-	-
9	16	22.6	12	49.4	22	-	-

NOTE: 1. For double storey brs the length of two ends of br (2e) must be added.
 2. Data for LRS short post. For long post, only MLC 60.

2. MGB Slope and Fatigue Data

SER	CONFIGURATION	MLC	LENGTH	CROSS SLOPE (Unlded)	INITIAL FATIGUE LIFE
1	Single storey	60	9.8m	1:10	10,000
		70(T)	9.8m	1:20	5,000
		100(W)	9.8m	0	7,500
2	Double storey	60	31.1m	1:20	10,000
		60(T)	32.9m	1:20	7,500
		70(T)	31.1m	1:20	5,000
		100(W)	27.4m	0	3,000
3	Double Storey Link Reinforced Short Post	60	49.9m	1:20	10,000
		70(T)	45.7m	1:20	10,000
		70(T)	49.9m	0	5,000
		100(W)	31.1m	0	
4	Double Storey Two Span With Span Junction	60	51.2m	1:20	10,000
		70(T)	51.2m	1:20	
		100(W)	36.6m	0	

3. Abbreviations

AR	Angle of repose	LRP	Landing Roller Pedestal
A(A')	Loc of AR peg on far (home) bank	LNH	Launching Nose Heavy
Baseline	Line at grd level joining FRB and RRB and extended to F and O, or the line at grd level joining RB and O and extended to F.	LNL	Launching Nose Lt
BP	Bottom Panel	LNR	Launching Nose Roller

BSB	Bank Seat Beam	LNXG	Launching Nose Cross Girder
CRB	Centre Roller Beam	LR	Launching Roller
DS	Double Storey	O	Pt distance R from RB/CRB/FRB
DU	Deck Unit	RB	Roller Beam
E	End of br	RRB	Rear Roller Beam
ETP	End Taper Panel		
FRB	Front Roller Beam		
F (F')	Loc of end of br pegs		
LRS	Link Reinforcement Set		

4. Summary of Distances

C	Height of water below (neg) line joining banks (F-FRB) at a dist. W from FRB.	L	LZ
D	Height of bottom of ETP above line joining banks (F-FRB) at a distance W from FRB	R	Max distance from RB/CRB/FRB to tail of br during const
G	Height of grd at 0 relative to baseline	T	Height of Tail of br at 0 relative to baseline
H	Height of grd at F relate to baseline	V	Max dist. between FRB/CRB and LRP for DS brs during de-launch when using a launching nose
LZ	Br Length (also F-F')	W	Distance of Front of ETP from FRB at max deflection

5. Dimensions of MGB components

a. Roadway width – 4.01 m	c. End of br – 4.6 m long
b. One bay of br – 1.83 m long	d. Ramp unit – 3.1 m long

6. Construction Times

SER	DETAIL	SINGLE STOREY	DOUBLE STOREY	DOUBLE STOREY LRS				
		4 Bay	8 Bay	12 Bay	12 Bay	18 Bay	22 Bay	20 Bay
(a)	(b)	(c)	(d)	(e)	(f)	(g)	(h)	(i)
1	Working Party	1+8	1+16	1+16	1+2 4	1+24	1+24	1+32
2	Time By Day (hr)	½	¾	1	1 ½	1 ¾	2	2 1/2
3	Time By Ni (hr)	¾	1	1 1/4	2	2 1/2	3	3 1/2

NOTES: 1. For timings under various MOPP conditions may be calculated from TAM 503.
2. Time for work on approaches not incl.
3. Increase timings at difficult sites.

7. Design of Single Spans:

<p>a. Recce.</p> <p>(1) Place AR pegs and measure AR span</p> <p>(2) Select br length and const</p> <p>(3) Mark br centre line and place pegs at F, F', RB/CRB/FRB/RRB and O.</p> <p>(4) Using RB/CRB/FRB peg as datum, take levels at F, F', RRB and O, and water level.</p> <p>(5) Check that slope of br is within limits.</p> <p>(6) Enter readings in design proforma and complete design of br using formulae.</p>	<p>b. Launching Restrictions.</p> <p>(1) Up to 12 bays: max crossfall 1 in 10.</p> <p>(2) Over 12 and all LRS: no crossfall.</p> <p>c. Windspeed limits.</p> <p>(1) Below Force 6: no limits.</p> <p>(2) Force 6-8: anchor br.</p> <p>(3) Over Force 8: do not launch.</p>	<p>d. Tfcking Restrictions.</p> <p>(1) Max slope of 1 in 10 in any dir (1 in 20 with LRS).</p> <p>(2) Max water current when LRS immersed is between 0.5 and 2.6 m/s with level deck and 1.0 m/s with slope 1 in 20, depending on br length.</p> <p>(3) Only one veh MLC 60 or above on br at any one time when LRS being used.</p>
---	--	--

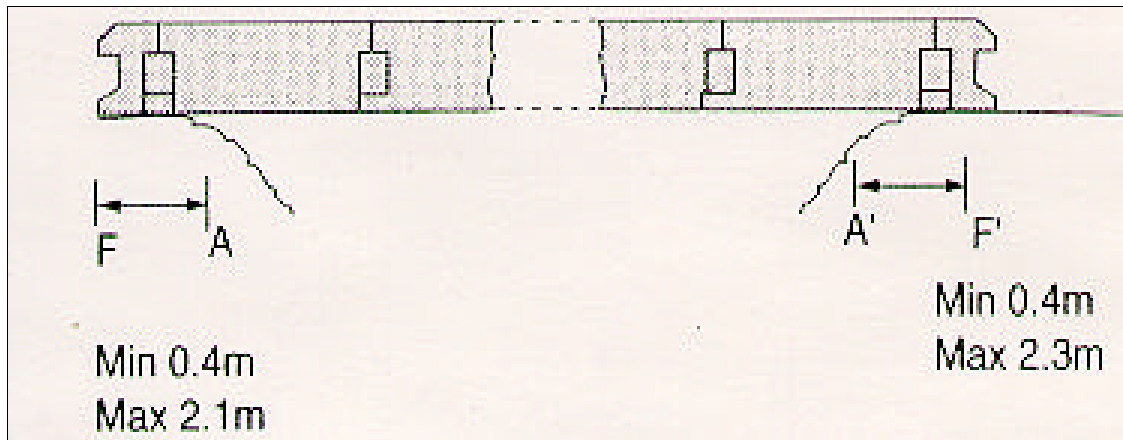

Criteria For SS Bridges

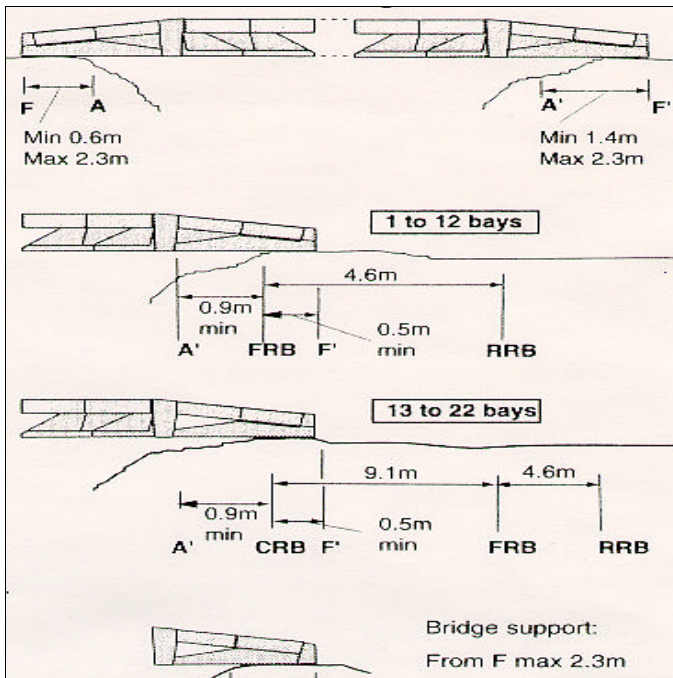

Criteria For DS Bridges

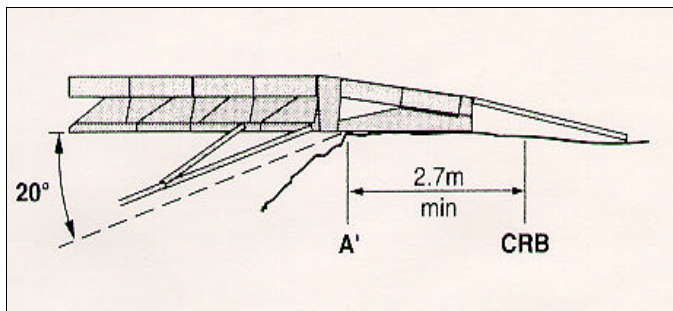

Criteria Using LRS (11-22 Bays)

8. MGB Design Proforma – Single Storey four to 12 Bays

Sheet No. Grid Ref. Site Name

MLC Name Unit

1. Measure AR span AA' =	m	Location	F	RB	O
		Datum Reading (RB)			
		Staff Reading			
		Reduced Level			

2. Enter from the table below:

- Bridge Selected
- Overall length
- Nose construction
- Dimension R

5 Draw graph to find H or use formula:

$$H = RF + \frac{HI \times (L \pm 0.2^*)}{\text{Dim R}}$$

Therefore $H = \dots + \left(\frac{\dots \times \dots}{\dots} \right) = \dots$

(Enter N from table below)

Up to 8 Bay

BP | BP + DU

3. Position Bridge

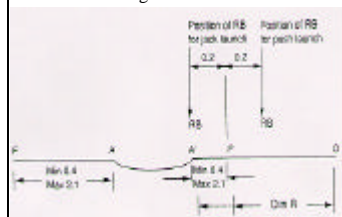

9 to 12 bays

BP			BP + DU		
H	M	L	H	M	L

Remember:

Conditions for push launch

1. 8 bays or less
2. No packing under RB
3. Front section of LNL removed

4. Take levels:

- *L+0.2 for PUSH launch
- *L-0.2 for JACK launch

7. FINAL DESIGN

Bays:.....

Launching System: RB on BP/
RB on BP + DU

For 9 to 12 bays LNXG:.....

Ser	AR Span	No of bays	Overall Length	MLC	Nose Const	Dim R	Dimension N above baseline through ground at RB and O					
							Roller Beam on BP (m)			Roller Beam on BP + DU (m)		
1	3.7-7.1	4	7.9	100(W)	LNL	5.8	1.30			1.75		
2	7.2-9.0	5	9.8	70(T)	LNL	6.7	1.14			1.68		
3	9.1-10.8	6	11.6	40	LNL	7.6	1.07			1.60		
4	10.9-12.6	7	13.4	40	LNL	9.5	0.76			0.91		
5	12.7-14.4	8	15.2	30	LNL	11.3	0.38			0.84		
							H	M	L	H	M	L
6	14.5-16.3	9	17.1	24	5NI	10.4	-0.76	0.61	1.83	-0.08	1.14	2.36
7	16.4-18.1	10	18.9	20	5NI	12.2	-0.99	0.38	1.60	-0.61	0.76	1.98
8	18.2-19.9	11	20.7	16	6NI	12.2	-1.37	0.15	1.83	-1.07	0.48	2.44
9	20.0-21.8	12	22.6	16	6NI	14.0	-2.13	-0.46	1.07	-1.60	0.08	1.60

9. MGB Design Proforma – Double Storey up to 22 Bays.

Sheet No. Grid Ref. Site Name
 MLC Name Unit

1. **Measure** AR span AA'
2. **Enter** from the table below
 - a. Bridge selected
 - b. Overall length
 - c. Dimension R
 - d. Nose construction
 - e. LZ No
 - f. V Dist
 - g. Dist W

bays
m

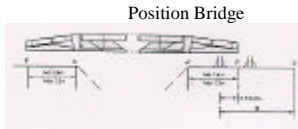

3. **Check:**
 $FA + AA' + A'CRB/FRB + 0.5 = L$
 $\dots + \dots + \dots + 0.5 = \dots$

Rule 1. $D > C$ Enter values of D from table in 805.21 para 10. Choose LNXG setting so that $D > C$.
 Circle value selected.

High	Med	Low	Possible settings

4. Take levels:

Location	F	WL	CRB/FRB	RRB	O
Datum Reading CRB/FRB					
Staff Reading					
Reduced Levels					

Rule 2. $N > H$, $T > G$. Enter t and values of N from table in 805.21 para 10. With LNXG setting(s) from Rule 1, check $N > H$ then check $T > G$. Circle value selected

T	High	Mid	Low	Selected Setting

5. Calculate C, H and G

1 to 12 bays
 $C = Ht \cdot WL - \frac{Ht \cdot F \times Dist \cdot W}{(L - 0.5)}$

$H = Ht \cdot F + \frac{Ht \cdot RRB \times (L - 0.5)}{4.6}$

$G = Ht \cdot O - \frac{Ht \cdot RRB \times Dim \cdot R}{4.6}$

13 to 22 bays
 $C = Ht \cdot WL - \frac{Ht \cdot F \times Dist \cdot W}{(L - 0.5)}$

$H = Ht \cdot F + \frac{Ht \cdot RRB \times (L - 0.5)}{13.7}$

$G = Ht \cdot O - \frac{Ht \cdot RRB \times Dim \cdot R}{13.7}$

Calculations
 $C =$
 $H =$
 $G =$

If $N > H$ and/or $T > G$ go to Rule 3.
Rule 3.
 1 to 12 bays. Raise FRB and RRB by 0.69 m.
 $N' = N + 0.69 = \dots + 0.69 = \dots$ m.
 $T' = T + 0.69 = \dots + 0.69 = \dots$ m.
 13 to 22 bays. Raise CRB and RRB by 0.25 m.
 $N' = N + 0.25 = \dots + 0.69 = \dots$ m.
 $T' = T + 0.25 = \dots + 0.25 = \dots$ m.
 Check $N' > H$ YES/NO $T' > T$ YES/NO
 Yes – OK. No – Rule 4a. Yes – OK. No – Rule 4a.

Rule 4a.
 1 – 12 bays. Lower RRB
 $N'' = N' + 1.75 (T + 0.69 - G)$
 $= \dots + 1.75 (\dots + 0.69 - \dots) = \dots$ m.
 13 – 22 bays. Raise CRB and lower RRB
 $N'' = N' + 1.9 (T + 0.42 - G)$
 $= \dots + 1.9 (\dots + 0.42 - \dots) = \dots$ m.
 Check $N'' > H$

Rule 4b.
 $T'' = T' + 0.2 (N' - H)$
 $= \dots + 0.2 (\dots + \dots) = \dots$ m.
 Check $T'' > G$

6. Follow rules 1 to 4

7. Final design.
 2E + LZ
 LNXG CRB/FRB RRB

10. MGB Design Table – Double Storey (up to 22 Bays)

MLC	AR SPAN	BAYS	LENGTH	DIM R	NOSE	LZ	V DIST	W	D			N			T
									H	M	L	H	M	L	
100(W) or 70(T)	6.4-9.0	1	11.0	10.0	2N1	3	11.6				+0.64	+1.12	+1.69	+0.55	
	9.1-10.8	2	12.8	11.9	3N1	8	13.7				+0.53	+1.18	+1.98	+0.55	
	10.9-12.6	3	14.6	12.2	3N1	5	15.5				+0.48	+1.13	+1.93	+0.55	
	12.7-14.5	4	16.5	13.1	3N1	4	17.0				+0.42	+1.06	+1.86	+0.55	
	14.6-16.3	5	18.3	14.9	4N1	8	19.2				+0.34	+1.18	+2.20	+0.52	
	16.4-18.1	6	20.1	14.9	4N1	5	21.0				+0.29	+1.12	+2.12	+0.52	
	18.2-19.9	7	21.9	15.8	4N1	4	22.6	13.1	+0.33	-0.06	-0.46	+0.17	+1.01	+1.98	+0.52
	20.0-21.8	8	23.8	16.8	5N1	8	24.7	15.0	+0.30	-0.12	-0.57	-0.03	+1.34	+2.37	+0.46
	21.9-23.6	9	25.6	17.7	5N1	5	26.6	16.5	+0.27	-0.18	-0.67	-0.18	+1.20	+2.22	+0.46
	23.7-25.4	10	27.4	19.5	5N1	3	28.0	17.6	+0.23	-0.25	-0.77	-0.22	+1.16	+2.18	+0.46
60(W) or 70(T)	25.5-27.3	11	29.3	20.4	6N1	8	30.2	18.5	+0.17	-0.33	-0.80	-0.31	+0.91	+2.40	+0.40
	27.4-29.1	12	31.1	21.6	6N1	5	32.0	19.2	+0.09	-0.43	-0.95	-0.45	+0.78	+2.24	+0.40
60	29.2-30.9	13	32.9	27.4	6N1	3	33.5	21.3	+0.05	-0.05	-0.60	-0.22	+1.01	+2.47	+0.84
50	31.0-32.8	14	34.8	28.7	7N1	7	35.7	22.6	+0.44	-0.14	-0.72	-0.69	+0.92	+2.60	+0.81
40	32.9-34.6	15	36.6	28.7	7N1	5	37.5	23.8	+0.38	-0.23	-0.84	-0.57	+0.83	+2.50	+0.78
40	34.7-36.4	16	38.4	29.6	7N1	3	39.0	25.0	+0.29	-0.35	-0.99	-0.48	+0.72	+2.38	+0.75
30	36.5-38.2	17	40.2	29.3	8N1	8	41.1	26.2	+0.02	-0.47	-1.15	-1.22	+0.38	+2.29	+0.71
30	38.3-40.1	18	42.1	29.3	8N1	5	43.0	27.4	+0.10	-0.60	-1.30	-1.49	+0.20	+2.12	+0.68
24	40.2-41.9	19	43.9	34.8	6N1+3N2	2	48.3	28.7	-0.02	-0.75	-1.48	-2.15	-0.35	+1.80	+0.65
24	42.0-43.7	20	45.7	38.4	6N1+3N2	4	49.1	30.2	-0.14	-0.90	-1.66	-2.28	-0.46	+1.63	+0.65
20	43.8-45.6	21	47.6	38.4	6N1+3N2	5	49.7	31.1	-0.29	-1.08	-1.88	-2.45	-0.64	+1.48	+0.62

MLC	AR SPAN	BAYS	LENGTH	DIM R	NOSE	LZ	V DIST	W	D			N			T
									H	M	L	H	M	L	
16	45.7-47.4	22	49.4	40.1	6N1+3N2	6	50.3	32.0	-0.47	-1.30	-2.12	-2.57	-0.76	+1.36	+0.59

11. Build and booming Stages and CG Position – up to 2E + 12 Bays (31.1m):

Br Length 2E+Bays	Nose Dim	Assemble E+I+	1st Boom	Add	Add	2nd Boom	Add	3rd Boom	Add	4th Boom	Add	LZ No
1	2N1	2N1(Bp7)	1p3	E (1p0)	-	-	-	-	-	-	-	3
2	3N1	3N1+2(Bp5)	1p6	E (1p0)	-	-	-	-	-	-	-	8
3	3N1	(Bp3)	1p2	2+3+3N1(Bp0)	-	2p4	E(1p6)	-	-	-	-	5
4	3N1	(Bp3)	1p2	2+3+3N1(Bp0)	4(Ap1)	3p0	E(2p3)	-	-	-	-	4
5	4N1	(Bp3)	1p2	2+3+4N1(Bp2)	4(Ap2)	3p0	5+E(2p5)	-	-	-	-	8
6	4N1	(Bp3)	1p2	2+3+4N1(Bp2)	4(Ap2)	3p0	5+6(1p6)	4p0	E(3p1)	-	-	5
7	4N1	(Bp3)	1p2	2+3+4N1(Bp2)	4(Ap2)	3p0	5+6+7(2p2)	4p4	E(3p6)	-	-	4
8	5N1	(Bp3)	1p2	2+3+5N1(Bp5)	4+ 5(1p0)	3p2	6+7+8(3p5)	4p6	E 3p7)	-	-	8
9	5N1	(Bp3)	1p2	2+3+5N1(Bp5)	4+ 5(1p0)	3p2	6+7+8(2p5)	4p6	9+E(4p3)	-	-	5
10	5N1	(Bp3)	1p2	2+3+5N1(Bp5)	4+ 5(1p0)	3p2	6+7+8(2p5)	4p6	9+10(3p5)	5p9	E(5p0)	3
11	6N1	(Bp3)	1p2	2+3+6N1(Bp7)	4+	3p0	6+7+8(2p3)	4p4	9+10+	6p1	E(5p2)	8

Br Length 2E+Bays	Nose Dim	Assemble E+1+	1st Boom	Add	Add	2nd Boom	Add	3rd Boom	Add	4th Boom	Add	LZ No
					5(Ap2)				11(3p7)			
12	6N1	(Bp3)	1p2	2+3+6N1(Bp7)	4+ 5(Ap2)	3p0	6+7+8(2p3)	4p4	9+10+ 11(3p7)	6p1	12+ E(5p6)	5

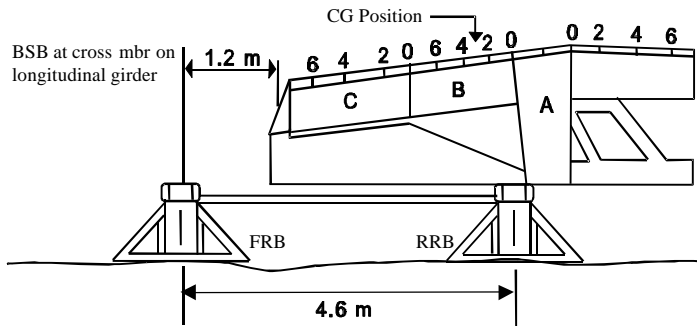

SITUATION: E+1 Bay Stage.

CG at Bp1. Build and boom in the order specified below.

() = Posn of CG in pp code.

SAFETY NOTE: Mark CG before booming and check that this does not approach within 2pp of either roller beam.

12. Const of DS Br 2E + 13 to 2E + 22 Bays

Ser	Br Length 2E+bays	LZ No	Type of Nose	1st step	Add	Add	2nd Boom	Add	3rd Boom	Add	4th Boom	Add
(a)	(b)	(c)	(d)	(e)	(f)	(g)	(h)	(i)	(j)	(k)	(l)	(m)
1	13	3	6N1		2+3+6 N1 (Bp7)	4+5 (Ap2)	3p0	6to8 (2p3)	4p4	9to11 (4p0)	11p0	12+13+E (6p2)
2	14	7	7N1		2+3+7 N1 (Cp2)	4+5+6 (1p0)	3p2	7to9 (2p5)	4p7	10to1 2 (4p2)	11p0	13+14+E (6p4)
3	15	5	7N1		2+3+7 N1 (Cp2)	4+5+6 (1p0)	3p2	7to9 (2p5)	4p7	10to1 2 (4p2)	11p0	13 to 15 + E (7p1)
4	16	3	7N1		2+3+7 N1 (Cp2)	4+5+6 (1p0)	3p2	7to9 (2p5)	4p7	10to1 2 (4p2)	11p0	13 to 15 + E (7p5)
5	17	8	8N1		2+3+7 N1 (Cp2)	4+8N1+5 +6 (Ap2)	3p0	7to9 (2p3)	4p5	10to1 2 (3p7)	10p7	13 to 7 + E (8p0)
6	18	5	8N1		2+3+7 N1 (Cp2)	4+6N1+5 +6 (Ap2)	3p0	7to9 (2p3)	4p5	10to1 2 (3p7)	10p7	13 to 18 + E (8p4)

Ser	Br Length 2E+bays	LZ No	Type of Nose	1st step	Add	Add	2nd Boom	Add	3rd Boom	Add	4th Boom	Add
(a)	(b)	(c)	(d)	(e)	(f)	(g)	(h)	(i)	(j)	(k)	(l)	(m)
7	19	2	6N1+3 N2		2+3+6 N1 (Bp7)	4+5+3N2 +6 (Bp2)	2p4	7to9 (2p0)	4p2	10to1 3 (4p0)	11p0	14to19+ E+20D (9p0)
8	20	4	6N1+3 N2		2+3+6 N1 (Bp7)	4+5+3N2 +6 (Bp2)	2p4	7to9 (7p0)	4p2	10to1 3 (4p0)	11p0	14to20+ E=20D (9p7)
9	21	5	6N1+3 N2		2+3+6 N1 (Bp7)	4+5+3N2 +6 (Bp2)	2p4	7to9 (2p0)	4p2	10to1 3 (4p0)	11p0	14to21+ E+20D (10p3)
10	22	6	6N1+3 N2		2+3+6 N1 (Bp7)	4+5+3N2 +6 (Bp2)	2p4	7to9 (2p0)	4p2	10to1 3 (4p0)	11p0	14to22+ E+20D (10p2)

805.22 - MEDIUM RAFT/MEDIUM FLOATING BRIDGING

1. MFB Design Characteristics

$$\% \text{ HBSS} = \frac{V}{H} \times 100$$

$$\% \text{ HBS} = \frac{V}{H} \times 100$$

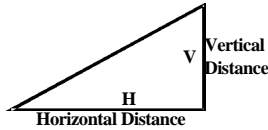

$$\% \text{ FBSS} = \frac{V}{H} \times 100$$

$$\% \text{ FBS} = \frac{V}{H} \times 100$$

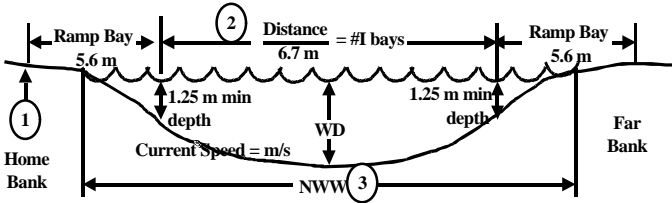

1. Start measurement at most suitable point where end of ramp bay is to be anchored (less ramp plates) and adjust measurement to meet 1.25 m min depth at 5.6 m.
2. To calculate the number of interior bays always round down, ie. $47 \text{ m} / 6.7 \text{ m} = 7.1 \text{ m} = 7$ interior bays.
3. If water is seasonal or tide affected note:
 - a. HWL, LWL and NWW; and
 - b. HWD, LWD and NWD.
4. Home bank slope must not be greater than 20% (1:5) longitudinal or 5% (1:20) lateral.
5. Calculate length of br and note where ramp plates are lowered (1.9 m) and if bridge will have wet or dry ramps. If wet ensure river/lake bottom will sp anticipated traffic ld

NOTE:

HWL = High Water Line

NWW = Nominal Water Width

LWD = Low Water Depth

HBSS = Home Bank Side Slope

FBSS = Far Bank Side Slope

LWL = Low Water Line

HWD = High Water Depth

NWD = Nominal Water Depth

HBS = Home Bank Slope

FBS = Far Bank Slope

2. Determine no of boats reqr to anchor br

Water speed (m/sec)	Bays held per boat
0.00 - 1.0	up to 6
1.01 - 1.8	up to 5
1.81 - 2.1	up to 4
2.11 - 2.7	up to 3

NOTE: One spare BBE is reqr as a safety boat and as a replacement of an unservice boat.

3. Tpt Reqrs

- a. Interior bays and ramp bays are tpt on HLVW or HESV with Bridge Adaptor Pallet (BAP).
- b. Reqr two x MLVW to tpt small stores.
- c. BBE tpt on HLVW or HESV with BAP

4. Std MR Set. Std MR set consists of 85m of MR consisting of:

- a. four x RB and eight x IB, and
- b. 12 x HLVW Floating Br Tpt

5. **MR Planning Times**

Bays Of Raft	Boats	Method Of Att	Water Current Speed	Mov	Speed Day and Ni Km/Hr	
					Lded	Unlded
3	1	Perpendicular	Fast	With	5	8
				Against	2	5
			Still	-	6	8
	2	Parallel	Fast	With	10	15
				Against	4	10
			Still	-	8	15
4	1	Perpendicular	Fast	With	Too dangerous	3
				Against		2
			Still	-		4
	2	Perpendicular	Fast	With	8	12
				Against	4	8
			Still	-	7	12
		Parallel	Fast	With	10	15
				Against	4	10
			Still	-	7	15
5	2	Perpendicular	Fast	With	5	8
				Against	2	5
			Still	-	6	12
		Parallel	Fast	With	10	15
				Against	4	10
			Still	-	7	15

6. **Labour**

- Launch BBE. BBE op, veh op, + 1,
- Pontoon launch via tpt. Veh crew of 2,
- Unfolding and locking. Two + BBE op,
- Coupling. 1 + 7,
- Op of br or raft. 1 + 7 + BBE ops, and
- Anchoring. 1 + 7 per shore.

7. **Boat Attachment**

- Perpendicular method.** BBE at 90 degrees to roadway. Most stable method. Allows best control as the BBEs are not separated by a ld and therefor provides better turning capability. Ldg on a restricted site difficult. Speeds in fast water reduced.
- Parallel method** - BBEs parallel to roadway. Greatest speed. Surest handling. Restricted to currents below 1.1 m/sec.
- Transfer method** - BBE att to the end of one ramp. **AVOID!** Little con over raft. BBE easily capsized or swept away.

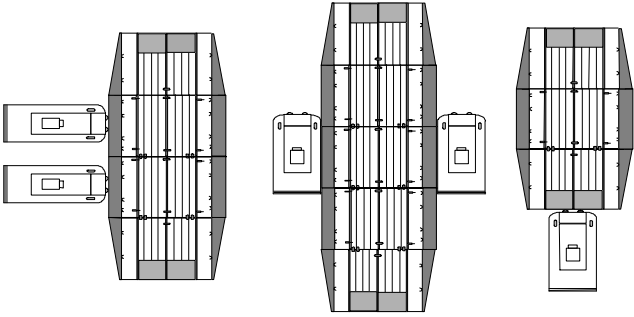

Boat Attachment

805.23 - MILITARY LOAD CLASS TABLES

Normal safe operating conditions against current	Water Depth (m)	Current Velocity (m/s)								
		0-1	1.25	1.5	1.75	2.0	2.25	2.5	2.75	3
3 Bay raft (2 Ramp Bays + 1 Interior Bay) (1)	1.0	22								
	1.4	33*	22	12						
	1.8			33*	22	12				
	2.5					33*	22	12		
	3.5						33*	22	12	-
	5.0							33*	22	12
4 Bay raft (2 Ramp Bays + 2 Interior Bays) (1)	1.2	43	22							
	1.4	60*	43	12						
	1.8			60*	33	22		Risk Area (2)		
	2.5					60*	33	22		
	3.5						60*	43	22	12
	5.0							55*	43	22
5 Bay raft (2 Ramp Bays + 3 Interior Bays) (1)	1.2	70	43							
	1.4	80*	70	33						
	1.8			80*	60	43				
	2.5					80*	60	43	22	

Normal safe operating conditions against current	Water Depth (m)	Current Velocity (m/s)								
		0-1	1.25	1.5	1.75	2.0	2.25	2.5	2.75	3
	3.5						60*	70	43	33
	5.0							75*	60	43

NOTES:

- (1) MLC based on gross multiple veh wt
 (2) Risk Area = Risk of catastrophic failure
 * Exceptional Ld = Wt may cause connector damage

Normal safe operating conditions against current	Water Depth (m)	Current Velocity (m/s)								
		0-1	1.25	1.5	1.75	2.0	2.25	2.5	2.75	3
6 Bay Raft (2 Ramp Bays + 4 Interior Bays)(1)	1.2	47								
	1.4	59	54							
	1.8	70	66	56						
	2.5	77	70	60	47					
	3.5	83	76	66	52	47	41			
	5.0	89	80	68	58	52	47	17		
7 Bay Raft (2 Ramp Bays + 5 Interior Bays)(1)	1.2	58								
	1.4	70	60							
	1.5	82	72	62						Risk Area (2)

Normal safe operating conditions against current	Water Depth (m)	Current Velocity (m/s)								
		0-1	1.25	1.5	1.75	2.0	2.25	2.5	2.75	3
	2.5		91	78	68	56				
	3.5		97	84	74	62	56	50		
	5.0		103	90	80	68	61	56	17	
8 Bay Raft (2 Ramp Bays + 6 Interior Bays)(1)	1.2		76							
	1.4		88	76						
	1.8		100	88	72					
	2.5		105	94	78	68				
	3.5		112	100	84	73	66	60		
	5.0		118	106	90	79	72	66	17	
NOTES:										
(1) MLC based on gross multiple veh wt										
(2) Risk Area = Risk of catastrophic failure										
* Exceptional Ld = Wt may cause connector damage										

Normal safe operating conditions against current	Water Depth (m)	Current Velocity (m/s)								
		0-1	1.25	1.5	1.75	2.0	2.25	2.5	2.75	3
9 Bay Raft (2 Ramp Bays + 7 Interior Bays)(1)	1.2		90							
	1.4		102	89	-	-	-			
	1.8		114	101	86	-	-			
	2.5		120	107	92	78	-	Risk Area (2)		
	3.5		126	113	98	84	76	70		
	5.0		132	119	104	90	82	75		
Br	1.2	70*	60	30						
	1.4		70*	50	30					
	1.8			70*	60	50	30			
	2.5					70*	60	40	20	
	3.5						70*	60	40	30
	5.0							70*	50	40
NOTES:										
(1) MLC based on gross multiple veh wt										
(2) Risk Area = Risk of catastrophic failure										
* Exceptional Ld = Wt may cause connector damage										

805.24 - LINE OF COMMUNICATIONS BRIDGING – ACROW

1. ACROW Br set consists of 48.8 m (16 Bays) of DSR2H. Width between ribands is 4.2 m

ACROW Planning Times				
MLC	Length (m)	Construction time in hrs		Manpower
		Day	Ni	
30	30.48	5	8	1 Sect
60	48.77	10	16	1 Sect

NOTES:

1. Method of erection is mech assisted (i.e. crane). Hand build is possible but not recommended.
2. Veh capacity 300 veh per hr.

2. ACROW pallet ld system configuration

Ser	Length	Grillage	5 Bays Nose	4 Bays Nose	First Two Bays	Two Centre Bays	Last Two Bays	Decking Ld	Ramp Ld	Total Pallets
1	12.2 m (4 bays)	1	1	-	1	-	1	1	1	6
2	18.3 m (6 bays)	1	1	-	1	1	1	1	1	7
3	24.4 m (8 bays)	1	1	-	1	2	1	1	1	8
4	30.5 m (10 bays)	1	1	1	1	3	1	2	1	11
5	36.6 m (12 bays)	1	1	1	1	4	1	2	1	12
6	42.7 m (14 bays)	1	1	1	1	5	1	2	1	13
7	48.8 m (16 bays)	1	1	1	1	6	1	2	1	14

NOTE: Based on 4 ESR trials in 1997. This configuration must be validated. Pallets are carried on HL/VW or HESV

3. Std ACROW Br Design by MLC and Span:

MLC	m ft	15.24 50	18.29 60	21.34 70	24.38 80	27.43 90	30.48 100	33.53 110	36.58 120	39.62 130	42.67 140	45.72 150	48.77 160	51.82 170	54.86 180	57.91 190	60.96 200	64.01 210	67.06 220	70.01 230	73.15 240	76.2 250
12		SS					SSRH								DS	DSR1H				DD		
16		SS					SSRH							DS	DSR1H				DD			
20		SS				SSRH						DSR1H						DD		DDR1 H		
24		SS			SSRH					DSR1H						DSR 2H	DD	DDR1H				
30		SS			SSRH	DS			DSR 1H					DSR2H			DDR1H					
40		SS	SSRH	DS			DSR2H										TSR2H	DDR1H				
50		DS				TS			DSR2H						TSR2H	TSR3H	DDR1H		DDR2 H			
60		DS			TS			DSR2H					TSR2H			TSR3H	DDR2H					

NOTE: All truss const are based on ONE veh per span.

805.25 - MGB OVERBRIDGING

1. The fol table gives the central deflection in mm of simply supported MGB SS brs under a trk veh of the MLC shown

Ser	No of bays	MLC	Dead Ld	Dead ld + live ld (central)	Dead ld + live ld (eccentric)
(a)	(b)	(c)	(d)	(e)	(f)
1	4	70(T)	15	51	58
2	5	70(T)	25	83	95
3	6	40	38	121	140
4	7	40	51	133	152(1)
5	8	30	70	190	222
6	9	24	89	210	241
7	10	20	108	267	310
8	11	16	146	324	381
9	12	16	184	406	495

NOTES:

1. This has not been cfm by test and may be greater.

2. The deflection under MLC 100(W) has not been tested but with 4 and 5 bay brs it should not be greater than that for MLC 70(T)

2. Clearance using Wedges. For a 4 bay br using wedges at the centre of the br - clearance under a live ld 110 mm. For a 4 bay br using wedges at the ends of the first and third panel - clearance under a live ld 116 mm.

805.26 - ENGINEER BOATS

Type	Description	Propulsion	Payld	Planning Capacity Of Current 1.5 M Per Sec (Lds Per Hr)		Carriage	Launch Planning Data		
				Waterway width			Party to launch	Day (mins)	Ni (mins)
(a)	(b)	(c)	(d)	100m	300m	(g)			
Recce boat	Pneumatic rubber boat. Wt 14 kg, length 2.8m, width 1.2m. 1 pers crew	Paddles or bridle line	three pers with recce kit			Recce veh	1	-	-
Aslt boat	Pneumatic rubber boat with transom. Wt 118 kg, length 5m, width 1.6m. 3 pers crew	Paddles in current up to 2.4 m/sec, 19 kw outboard motor up to 3.4 m/sec	12 armed pers	Paddling -12 Outboard - 17	Paddling - 6 Outboard - 12	20 boats and motors per HESV w/tr	Inflate 3 pers Carry boat 8 pers Carry motor 2 pers	-	-
Br Boat Erection (BBE) (3)	Aluminum. Wt 5200 kg with fuel and eqpt. Length 7.58m, width 3.37m, draft 0.5m (full ld). 2 pers crew	Twin water jet	n/a			HLVW with BAP	Veh op and BBE crew	1(1) 5(2)	2(1) 5(2)
NOTES: 1. Free launch. 2. Con launch. 3. Static thrust no less than 2,273 kg fwd and 1,336 kg in reverse.									

805.27 - ASLT BOAT CROSSING LAYOUT

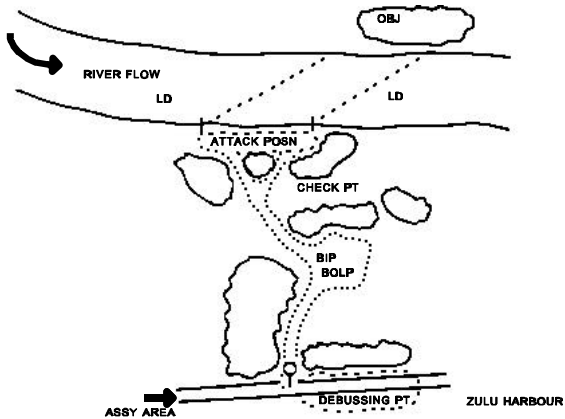

805.28 - FERRY SITE LAYOUT

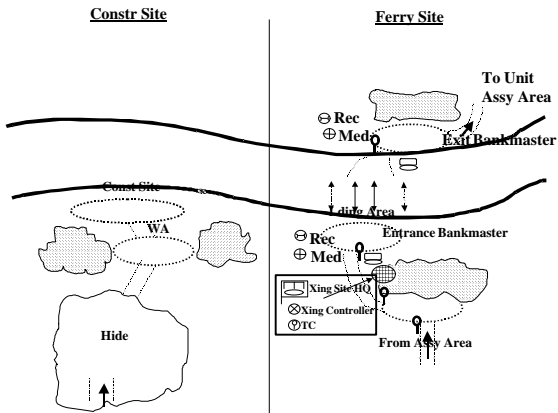

805.29 - COUNTER MINE EQPT

1. Mine Roller

<p>a. Gen Description. The minefield breaching rollers (MBR) are installed on the front of the Leo MBT to detonate land mines in the path of the veh. A drag chain is suspended between the roller assy to detonate tilt-rod fuse mines that lie between the paths clr by the rollers. The eqpt incl two gps - a roller set and an adapter set.</p>	
<p>b. Tech Info</p> <ol style="list-style-type: none">(1) The system is designed to withstand the detonation of ten mines each containing 10 kg of high expls(2) Under normal trg conditions replacement of some components may be nec after 300 km of op(3) Life expectancy is 10 yrs normal use(4) Can detonate mines buried under up to 10 cm (4 inches) of cover(5) Max speed in minefield 7 kph(6) Max ditches .5 m deep 5 kph(7) Max hard surface 16 kph(8) Vertical step max 1.15 m(9) Trench crossing max 3 m(10) Max side slope 30%	<p>c. Dimensions</p> <ol style="list-style-type: none">(1) Length 2.74 m(2) Width 4.41 m(3) Overall length (w/tk) 10.91m(4) Height 1.44 m(5) Max height 1.74 m(6) Rolled width (ea trk) 1.22 m(7) Unrolled width 1.77 m

2. Mine Plough. Characteristics are as fol

<p>a. Tech Info</p> <ol style="list-style-type: none">(1) Wt with extensions 3000 kg(2) Ploughed width (ea trk) 1.02 m(3) Unploughed width (between trks) 1.50 m(4) Grd Clearance (plough raised) 440 mm(5) Angle of approach 18 degrees(6) Ploughing depths (adjustable) 20, 25 and 30 cm(7) Speed 7 kph.	<p>b. Diminsions</p> <ol style="list-style-type: none">(1) Length 2.86 m(2) Width (less moldboard extension) 35.56 cm(3) Width (with moldboard extension) 45 cm(4) Height (mtd) 1.39 m
---	--

3. Pearson Mine Plough (SMCD)

a. Clrs scatterable munitions up to 1.5kg.

4. Joint Svcs Flail Unit (Ardvark)

a. Clrs all known mines buried or surface laid.

b. Speed 3-5 kph.





c. **Survival.** Can survive a 10kg blast. Unit is 60% effective.

Level 1 clearance to fol.

COUNTER MOBILITY SP

805.30 - BARRIER PLANNING

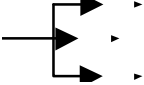
1. Barrier planning coincides with manoeuvre planning at all levels. At ea level, a barrier plan is dev by the sp engr and disseminated as part of the manoeuvre order as well as graphically. Barrier plans are disseminated at each manoeuvre level as listed:

Manoeuvre Level	Barrier Plan Depiction	Obs Effect Symbols (2)	
Corps	Zones	Fix: slow – confuse the en so that he may be eff engaged with dir and indir fire.	
Div	Zones (1)	Turn: Force the en turn his fmn in the indicated dir.	
Bde	Belts	Disrupt: Break up the en fmn/coord. Short arrows show which part of the fmn should be affected.	
Bn	Gps	Block: Do not allow the en to pass. Defeat the en breaching capability.	
Coy	Obs		
<p>NOTES:</p> <ol style="list-style-type: none"> 1. Obs effects are incl beginning at div level. 2. Comd depict their intent for obs using effect symbols. Symbols for zones and belts show the desired effect for the zone or belt. Obs effects for gps show exactly where the effect is to take place. 			

2. Comds at any level may dir obs at a lower level. A div comd may dir an obs belt, gp, or an indiv obs.

3. **Obs No.** Obs are numbered IAW FSOP 303.

8-74 **805.31 - CANADIAN MINES AND VEHICLE MINE CARRYING CAPACITY**

1. Current Canadian AT mines

SER	MINE	DESCRIPTION	PACKAGING	ARMING	DISARMING
(a)	(b)	(c)	(d)	(e)	(f)
1	FFV 028 AT mine	Type: blast type made of metal. Wt: 8kg Expl wt: 3.9kg Fuze: Elec which measures changes in the mag fd	Each unit ld consists of 30 mines in a six-unit package on a pallet	a. Depress the safety button and at the same time depress the arming lever and turn it to "f" b. Complete the cam	a. The procedure is unknown at this time b. Wait 40 days for red flag to be fired out of the mine. At that time mine is safe to handle
2	DM21 AT mine	Wt: 9.3kg Expl: 5.0kg Fuze: DM1001, pressure with 5 min arming delay device. 180 kg pressure.	Four mines and four fuzes in wooden box (46.0 kg)	a. Unscrew arming plug, ensure lever on "s" b. Open fuze container and set aside lower part. Ensure fuze is not armed (if so, set aside) c. Place upper part in fuze cavity (curved notch pt to white dot on pressure plate) d. Push fuze in mine until it snaps home e. Pull off upper part of fuze container and screw in arming plug	a. Remove arming plug b. Place upper part of fuze container on fuze and line up notch with white dot c. Push upper part of container onto fuze until it snaps in place d. Turn 90° (either way) and pull out part with fuze e. Reset timer with lower fuze cover f. Replace fuze in container g. Push down arming lever with lower part of fuze tin

SER	MINE	DESCRIPTION	PACKAGING	ARMING	DISARMING
(a)	(b)	(c)	(d)	(e)	(f)
				f. Press down arming button while turning arming lever from "s" to "f". Arming device will tick, mine will be armed in five mins	h. Turn arming lever to "s" i. Screw arming plug onto mine. NOTE: Mine cannot be neutralized
3	C14 off rte mine	WT: 10.2 KG Warhead: HEAT, 500g Cast Octol 70/30.	ONE LAUNCH ASSY, ONE TRIPOD ASSY, M42/P FIRING DEVICE, TRIP WIRE (100 M) AND COTTON PULL CORD (100 M)	a. Loc the tripod in a suitable posn (20-150 m along a LOS) from the proposed tgt aiming pt and sandbag tripod legs or otherwise secure in place b. Att lchr to tripod assy. Open sight covers and aim the lchr at the proposed aim pt c. Tighten handle on the tripod assy to lock the launch tube in place d. Att the squib end of the shock tube to the launch tube percussion firing mechanism by inserting the squib in the squib housing and secur it using the screw in adapter fitting. Secur the non-elec shock tube to avoid any dir pull on the	a. Neutralize the mine b. Ensure the M42/P firing device is in safe custody before leaving the firing posn to disarm the mine c. Insert the safety pin in the launch tube percussion firing mechanism d. Unscrew the adapter fitting from the percussion mechanism e. Disconnect the squib end of the shock tube from the adapter fitting f. Replace the adapter fitting g. Recoil the shock tube and repack the components in the shipping box

SER	MINE	DESCRIPTION	PACKAGING	ARMING	DISARMING
(a)	(b)	(c)	(d)	(e)	(f)
				adapter fitting which may result in a misfire e. Remove the launch tube percussion mechanism safety pin, but leave it att to the elastic cord provided	

2. Veh Mine Carrying Capacity

MINE TYPE	VEH TYPE (1) (2)					QTY/ PALLET	MAX PAL. WT (Kg)
	LSVW	MLVW	HLVW	HESV or Trl	M548		
	2 Pallets	6 Pallets	8 Pallets	10 Pallets	4 Pallets		
FFV 028	60	180	240	300	120	30	240
DM21	112	336	448	560	224	56	670

- NOTES:** 1. All figs based on mines on pallets, not indiv or on mine racks.
 2. No of pallets shown per veh is the max that will fit without stacking.
 3. 1 x HLVW will carry sufficient fencing stores for a 4.5 km perimeter.
 4. Info for FFV 028 are estimations only.

805.32 - ALLIED SCATTERABLE MINES DATA

SER	SYSTEM	DESCRIPTION	MINE	ARMING	SAFE ARM TIME	WARHEAD	SELF DESTRUCT
(a)	(b)	(c)	(d)	(e)	(f)	(g)	(h)
1	VOLCANO	The Volcano system can be configured as both a heliborne and grd del mine system. The M139 mine dispenser, with various adapter kits, is capable of being mtd on UH-60 hel and a variety of grd veh. The system has a capacity of up to 960 mines and is capable of producing a mined area approx 1150 m x 125 m. Fusing: magnetic Sensing width: veh Anti handling devices: no Expl wt: 1.3 lbs Mine wt: 3.8 lbs	BLU-91/B	Bore Pin Elec Impulse	2 min	M-S Plate	4 hrs 48 hrs 15 days
2.	RAAM	The Remote Anti-Armour Mine (RAAM) is a 155mm how launched AT mine system. Nine AT mines are packed into a carrier rd. The rds contain mines with long and short self-destruct times. The mine contains a MI fuse	M741 M718	G force Spin	45 sec 2 min	M-s plate	4 hrs 48 hrs

SER	SYSTEM	DESCRIPTION	MINE	ARMING	SAFE ARM TIME	WARHEAD	SELF DESTRUCT
(a)	(b)	(c)	(d)	(e)	(f)	(g)	(h)
		which atks the full width of a tk. FUSING – MAGNETIC Sensing width – veh Anti handling devices – 20% Expl wt – 1.3lbs Mine wt – 3.8lbs					

805.33 - MINELAYING

1. **Coord of Minefield Planning.** During all stages of planning and exec, minefields must be coord with the fol:

- a. **A-Armour Plan.** Depth of minefield and distance from def posns must permit A-armour wpns to engage en at fwd edges and beyond.
- b. **Indir Fire Plan.** Lanes and gaps must be sufficiently covered.
- c. **Ptl Plan.** Ptl lanes must be marked, lanes should be periodically reloc to prevent ambush.
- d. **Manoeuvre Plan.** Minefields must be sited so they do not interfere with planned manoeuvre of friendly forces.
- e. **Countermove Plan.** Gaps must be aval where nec to permit passage of countermove forces in tac fmn, provision for closing these gaps must be incl in planning. Add minefields may be nec to protect flanks of countermove forces.
- f. **Withdrawal Plan.** Lanes through minefields must be aval and marked, nuisance mining must be complete fol wdr.
- g. **Deception Plan.** Marking of minefield must not disrupt deception plan or give away loc of friendly posns.
- h. **Admin Plan.** Mines, stores, tpt and pers must be aval in sufficient qty and a appropriate locs. Ress should be pushed fwd to allow sqn/tps to sp BG immed. If sufficient ress have not been alloc they should be demanded.
- i. **Plans of Adjacent Unit.** Coord must be done to ensure that:
 - (1) Minefields are tied-in and anchored along common bdry.
 - (2) There is mutual fire coverage and surv of minefields along unit bdry.
 - (3) Adjacent units can exec op plans, incl ptl and countermove.

2. **Siting Considerations:**

- a. Always covered by dir and/or observed indir fire (exception – nuisance minefields).
- b. Far enough fwd of def posns to prevent en from using effective small arms fire, but close enough to prevent him using arty without endangering his own tps while minefield is being breached.
- c. Sited in conjunction with other obs (natural and man-made) and difficult or time consuming to bypass.
- d. Layed in such a way as to min risk of being detected before contact is made (eg. Using existing fences, reverse slopes) and in locs not expected by en.

3. **Minefield Recce Checklist**

a. Info Reqr Prior to Recce: (1) type (tac, protective, nuisance, phoney); (2) ser and loc (usually 4 grids); (3) type and density;	b. Recce Details: (1) mines (type and no), labour, fencing stores and hy eqpt reqr; (2) detailed sketch of minefield to incl: dimensions, landmarks and features, intermediate markers, strip/row
--	---

<p>(4) no of rows and spacing; (5) laying drill (Drill Z, scattered, other); (6) method of laying (surface/buried, mech/hand); (7) lane (ptl/veh) and gap reqrs, method of closure; (8) anti-lift/anti-disturbance devices; (9) AT ditch reqrs, incl locs; (10) ln reqr (if so – purpose, time and loc); and (11) proposed tp har loc.</p>	<p>markers, dir of lay, perimeter fence, lane/gap locs, bearings and distances, type of grd, veh mov plan, minefield con pt, dist and dir to cache; (3) detailed sketch of cache to incl: exact loc, size in and out rte, ld/unld areas, conveyor area (30m long), existing features and type of grd, veh area, dist and dir to minefield and har; and (4) detailed sketch of har to incl: exact loc, scale, in and out rte, veh locs, dist and dir to cache and minefield.</p>
---	---

4. **Tac Reports on Minefields**

SER	REPORT	PURPOSE	FROM - TO	COMMENTS
(a)	(b)	(c)	(d)	(e)
1	E122A Mine Laying Recce Order	To order a minefield recce	Regt to sqn or sqn to tp or tp to Recce Sgt.	See Rep and Ret Sect Engr TAM or USOP Part 7.
2	E122B Mine Laying Recce Report	To report the details of a minefield recce	Recce Sgt to tp or tp to sqn or sqn to regt	As per ser 1 comments.
3	E122C Mine Laying Order	To order the laying of a minefield	Regt to sqn or sqn to tp	As per ser 1 comments.
4	E122D Minefield Completion Report	To report the details of a completed minefield	Tp to sqn or sqn to regt	As per ser 1 comments.
5	E306 Intention to Lay Minefield Report	To provide the means of disseminating info relating to a tac comd's intent to lay a minefield.	Tp to Sqn, Sqn to BG HQ	As per ser 1 comments. Under barrier planning, BG will fwd a consolidated barrier overlay to Bde HQ. Therefore, provided the BG has emplacement auth, this msg not reqr higher than BG HQ. Or this report is reqr if the tac comd wishes to const a minefield and does not have emplacement auth.

5. Std Minefield Designs

Type	Description	Minefield Layout (1)	Mine Spacing	No Of Mines (2) (1000 m. Frontage)		Eld(3)	Time To Lay 1000 m (Tp Hrs)	Stopping Power (4)
				SI	MI			
A	SI only	6 SI	6 m	1000		1.0	4	Low
B	Row A MI, remainder SI	1MI/2SI	6 m	334	167	0.5	2	Low
C	MI only. Spacing as noted.	3MI	10 m		300	0.3		Low
		5MI	10 m		500	0.5		Med
		10MI	10 m		1000	1.0		High
		MI	6 m		1000	1.0		High
D	Row A-B MI , remainder SI	2MI/2SI	6 m	334	334	0.67		Med
E	Row A-B-C MI remainder SI	3MI/2SI	6 m	334	500	0.83		Med

NOTES: 1. SI = single impulse, MI = magnetic impulse.

2. No of rows any types of mines in the row. "2MI" means two rows of MI mines.

3. Effective linear density (ELD) expressed as mines per m frontage.

4. As a gen rule, minefields in blocking gps are high stopping power. Minefields in turning and fixing gps are med stopping power. Minefields in disrupting gps are low stopping power.

805.34 - MINEFIELD LANE MARKING

1. Day Marking of Minefield Lane

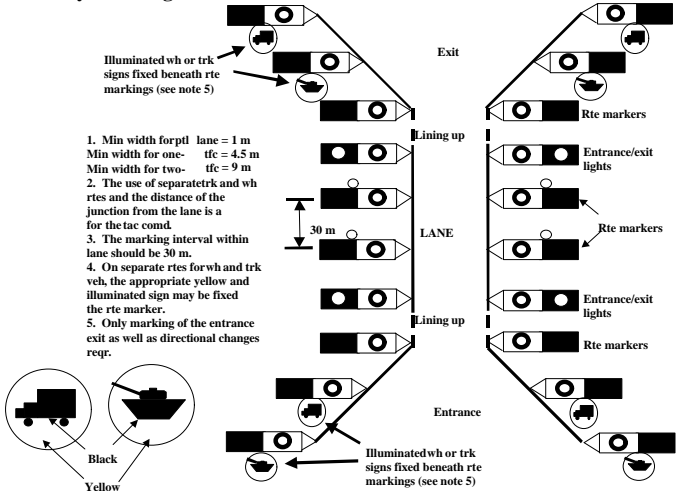

2. Ni/Low Visibility Marking of Minefield Lane

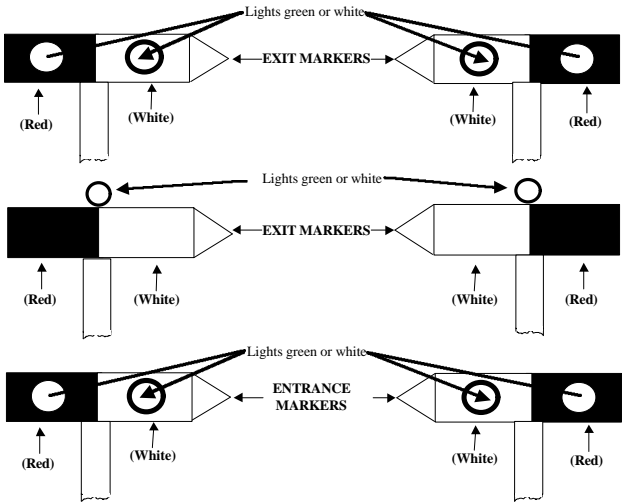

805.35 - BOOBY TRAPS

1. **Resp.** Booby traps may only be used on the auth of the div comd. Only engrs or aslt pnrs may lay them.
2. **Principles:**
 - a. Concealment. Traps should be concealed or made to resemble a harmless object.
 - b. Constricted Localities. The more constricted the site, the harder to detect and clear.
 - c. Concentration. Traps should be laid in large no to reduce the chances of finding them all without springing some. Use dummies freely.
 - d. Double Bluff. Use an obvious trap to hide a well concealed trap nearby.
 - e. Inconvenience. Traps may be sprung by the removal of obs, furniture or litter.
 - f. Curiosity. Souvenirs, food, drink, wpns can be used.
 - g. Everyday Ops. Opening or closing doors, lt switches, tel, toilets etc. can all hide a trap.
 - h. Attraction. Delay action or incendiary bombs may attract pers to a booby trap site.
 - i. Altn Methods of Firing. A trap may have two or more methods of firing.
 - j. Variety. Use as many different types as possible.
3. **F1A1 Booby Trap.** The std issue trap is the F1A1 Combination Switch. It operates under a pressure of 11.3kg, a pull of 3.2kg and a release of tension of pressure of 1.1kg. Charges of 0.25kg of expl should be used against pers, 5-10 kg against tks.
4. **Improvised Traps.** Improvised devices can either be expl, using improvised elec switches, or non expl. Restrictions on their use are:
 - a. when recording traps, full details must be given of their mechanism and how to disarm them;
 - b. improvised traps should be empl only in areas that the en is almost certain to occupy; and
 - c. delay action devices should either be in a loc where it is unlikely friendly tps will pass within the period of the delay, or be of sufficiently short delay so that there is no danger to friendly tps.
5. **Procedure for setting up Booby Traps:**
 - a. inspect F1A1 mechanism to ensure it will not fire prematurely when the pin is removed;
 - b. consider time, lab and mat aval, decide on exact posn and design of each booby trap;
 - c. estb safe rtes, con pts and ammo pts;
 - d. keep tight con of pers, keep parties as small as possible;
 - e. laying is carried out by laying party;
 - f. OIC inspects each trap to ensure it is properly laid, pers return to con pt with stores;

- g. all pers must be out of danger area before traps are armed. Arming must be done in a logical sequence (ie. top floor first) by either comd or 2IC. Withdrawing safety pin then joining det cord arms trap; and
- h. OIC or a pers detailed by him must record traps as they are laid. The same recording and reporting principles apply as when laying mines.

6. **Booby Trap Detection and Clearance.** Before beginning a search, a suitable party must be organised and equipped. Clear orders must be issued covering the degree of damage and risks that is to be acceptable. Unless special orders are issued, clearance parties will not attempt to hand neutralise traps.

7. **Clearance Eqpt**

a. Metal detectors and prodders. Detectors are rarely of much use indoors because booby traps are often concealed near metal objects. Outdoors they are extremely valuable. Prodders are useful outdoors for detecting hand buried obj and for revealing loc where hard grd has recently been disturbed.	c. Grapnels and cable. A 50 m cord fitted with a grapnel hook.	h. Mine tape.
	d. Rad comms.	i. Expl
	e. Chalk/Spray paint. Reqr to mark progress inside or outside of bldgs.	j. Trip wire feelers. Const with sufficient stiffness (i.e. 14 SWG). Used indoors and outside to search for the presence of tension/tension release devices.
	f. Marking signs.	
b. Safety glasses.	g. Ladder.	k. Fire fighting eqpt

8. **Searching Bldgs**

a. Turn off electricity and gas svcs to the bldg.	e. Comd must estb a con pt that may serve as a firing pt. This pt must be searched and clr of booby traps.	i. Comd determines pattern of search, details pers.
b. No more than two people working in the same room.	f. Comd must conduct a visual recce of the bldg.	j. Search parties search rooms. When the search for a room is finished, the party will mark the door with chalk as “ CLEARED ” or “ BOOBY TRAPS ” and will report results to the comd.
c. Search only onw floor and only half the rooms on the	g. Comd must estb an entry pt and details a party to clr a 1 m wide rte and effects an entry into the bldg. Doors should be	k. Comd will detail subsequent rooms for search

floor at a time.	avoided, and windows carefully searched. If doors and windows suspected, enter by the roof or create a hole in the wall.	
d. Parties should work as far apart as possible.	h. Comd and an asst enter the bldg and estb an interior con pt, clr the way of booby traps as they go. Rtes are marked on the floor.	l. Comd must decide how to dispose of booby traps.

805.36 - BRIDGE CATEGORISATION

1. Br Categorisation Simply Supported Brs

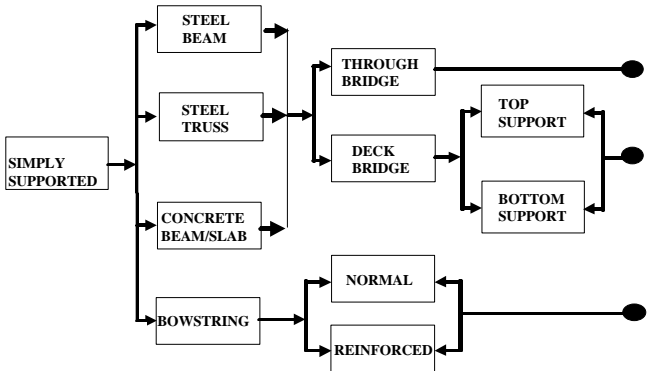

2. Br Categorisation of Continuous Brs

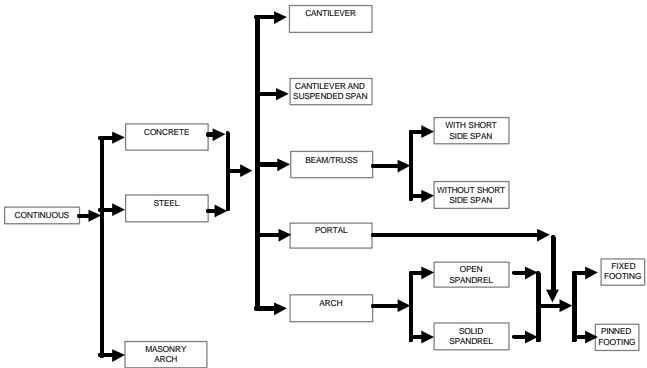

805.37 - METHODS OF ATK FOR SIMPLY SUPPORTED SPANS

1. Recce Measurements – End Clearance Reqr (E_R) for Bottom Atk

H/L	E_R/L	H/L	E_R/L
0.01	0.0002	0.11	0.024
0.02	0.0008	0.12	0.029
0.03	0.002	0.13	0.034
0.04	0.003	0.14	0.039
0.05	0.005	0.15	0.044
0.06	0.007	0.16	0.05
0.07	0.01	0.17	0.057
0.08	0.013	0.18	0.063
0.09	0.016	0.19	0.07
0.10	0.02	0.20	0.077

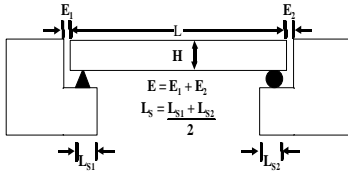

2. Min Length of Sect to be Removed (L_C) for Midspan Atk

Ls/L	H/L																			
	0.010	0.020	0.030	0.040	0.050	0.060	0.070	0.080	0.090	0.100	0.110	0.120	0.130	0.140	0.150	0.160	0.170	0.180	0.190	0.200
0.004	0.003	0.005	0.008	0.010	0.013	0.015	0.018	0.020	0.023	0.025	0.028	0.031	0.033	0.036	0.038	0.041	0.043	0.046	0.048	0.051
0.005	0.003	0.006	0.009	0.011	0.014	0.017	0.020	0.023	0.026	0.028	0.031	0.034	0.037	0.040	0.043	0.046	0.048	0.051	0.054	0.057
0.006	0.003	0.006	0.009	0.013	0.016	0.019	0.022	0.025	0.028	0.031	0.034	0.038	0.041	0.044	0.047	0.050	0.053	0.056	0.059	0.063
0.007	0.003	0.007	0.010	0.014	0.017	0.020	0.024	0.027	0.030	0.034	0.037	0.041	0.044	0.047	0.051	0.054	0.057	0.061	0.064	0.068
0.008	0.004	0.007	0.011	0.014	0.018	0.022	0.025	0.029	0.033	0.036	0.040	0.043	0.047	0.051	0.054	0.058	0.062	0.065	0.069	0.072
0.009	0.004	0.008	0.012	0.015	0.019	0.023	0.027	0.031	0.035	0.038	0.042	0.046	0.050	0.054	0.058	0.062	0.065	0.069	0.073	0.077
0.010	0.004	0.008	0.012	0.016	0.020	0.024	0.028	0.032	0.037	0.041	0.045	0.049	0.053	0.057	0.061	0.063	0.069	0.073	0.077	0.081
0.011	0.004	0.009	0.013	0.017	0.021	0.026	0.030	0.034	0.038	0.043	0.047	0.051	0.055	0.060	0.064	0.068	0.073	0.077	0.081	0.085
0.012	0.004	0.009	0.013	0.018	0.022	0.027	0.031	0.036	0.040	0.045	0.049	0.054	0.058	0.062	0.067	0.071	0.076	0.080	0.085	0.089
0.013	0.005	0.009	0.014	0.019	0.023	0.028	0.033	0.037	0.042	0.047	0.051	0.056	0.060	0.065	0.070	0.074	0.079	0.084	0.088	0.093
0.014	0.005	0.010	0.015	0.019	0.024	0.029	0.034	0.039	0.044	0.048	0.053	0.058	0.063	0.068	0.073	0.077	0.082	0.087	0.092	0.097
0.015	0.005	0.010	0.015	0.020	0.025	0.030	0.035	0.040	0.045	0.050	0.055	0.060	0.065	0.070	0.075	0.080	0.085	0.090	0.095	0.100
0.016	0.005	0.010	0.016	0.021	0.026	0.031	0.036	0.041	0.047	0.052	0.057	0.062	0.067	0.073	0.078	0.083	0.088	0.093	0.099	0.104
0.017	0.005	0.011	0.016	0.021	0.027	0.032	0.037	0.043	0.048	0.054	0.059	0.064	0.070	0.075	0.080	0.086	0.091	0.096	0.102	0.107
0.018	0.006	0.011	0.017	0.022	0.028	0.033	0.039	0.044	0.050	0.055	0.061	0.066	0.072	0.077	0.083	0.088	0.094	0.099	0.105	0.110
0.019	0.006	0.011	0.017	0.023	0.028	0.034	0.040	0.045	0.051	0.057	0.062	0.068	0.074	0.079	0.085	0.091	0.097	0.102	0.108	0.114
0.020	0.006	0.012	0.018	0.023	0.029	0.035	0.041	0.047	0.053	0.058	0.064	0.070	0.076	0.082	0.088	0.093	0.099	0.105	0.111	0.117
0.021	0.006	0.012	0.018	0.024	0.030	0.036	0.042	0.048	0.054	0.060	0.066	0.072	0.078	0.084	0.090	0.096	0.102	0.108	0.114	0.120
0.022	0.006	0.012	0.018	0.025	0.031	0.037	0.043	0.049	0.055	0.061	0.068	0.074	0.080	0.086	0.092	0.098	0.104	0.110	0.117	0.123
0.023	0.006	0.013	0.019	0.025	0.031	0.038	0.044	0.050	0.057	0.063	0.069	0.075	0.082	0.088	0.094	0.101	0.107	0.113	0.119	0.126
0.024	0.006	0.013	0.019	0.026	0.032	0.039	0.045	0.051	0.058	0.064	0.071	0.077	0.084	0.090	0.096	0.103	0.109	0.116	0.122	0.129
0.025	0.007	0.013	0.020	0.026	0.033	0.039	0.046	0.053	0.059	0.066	0.072	0.079	0.085	0.092	0.099	0.105	0.112	0.118	0.125	0.131
0.026	0.007	0.013	0.020	0.027	0.034	0.040	0.047	0.054	0.060	0.067	0.074	0.081	0.087	0.094	0.101	0.107	0.114	0.121	0.128	0.134
0.027	0.007	0.014	0.021	0.027	0.034	0.041	0.048	0.055	0.062	0.069	0.075	0.082	0.089	0.096	0.103	0.110	0.117	0.123	0.130	0.137
0.028	0.007	0.014	0.021	0.028	0.035	0.042	0.049	0.056	0.063	0.070	0.077	0.084	0.091	0.098	0.105	0.112	0.119	0.126	0.133	0.140
0.029	0.007	0.014	0.021	0.029	0.036	0.043	0.050	0.057	0.064	0.071	0.078	0.086	0.093	0.100	0.107	0.114	0.121	0.128	0.135	0.143
0.030	0.007	0.015	0.022	0.029	0.036	0.044	0.051	0.058	0.065	0.073	0.080	0.087	0.094	0.102	0.109	0.116	0.123	0.131	0.138	0.145
0.031	0.007	0.015	0.022	0.030	0.037	0.044	0.052	0.059	0.067	0.074	0.081	0.089	0.096	0.103	0.111	0.118	0.126	0.133	0.140	0.148
0.032	0.008	0.015	0.023	0.030	0.038	0.045	0.053	0.060	0.068	0.075	0.083	0.090	0.098	0.105	0.113	0.120	0.128	0.135	0.143	0.150
0.033	0.008	0.015	0.023	0.031	0.038	0.046	0.054	0.061	0.069	0.077	0.084	0.092	0.099	0.107	0.113	0.122	0.130	0.138	0.145	0.153
0.034	0.008	0.016	0.023	0.031	0.039	0.047	0.054	0.062	0.070	0.078	0.086	0.093	0.101	0.109	0.117	0.124	0.132	0.140	0.148	0.156
0.035	0.008	0.016	0.024	0.032	0.040	0.047	0.055	0.063	0.071	0.079	0.087	0.095	0.103	0.111	0.119	0.126	0.134	0.142	0.150	0.158
0.036	0.008	0.016	0.024	0.032	0.040	0.048	0.056	0.064	0.072	0.080	0.088	0.096	0.104	0.112	0.120	0.128	0.137	0.145	0.153	0.161
0.037	0.008	0.016	0.024	0.033	0.041	0.049	0.057	0.065	0.073	0.082	0.090	0.098	0.106	0.114	0.122	0.130	0.139	0.147	0.155	0.163
0.038	0.008	0.017	0.025	0.033	0.041	0.050	0.058	0.066	0.074	0.083	0.091	0.099	0.108	0.116	0.124	0.132	0.141	0.149	0.157	0.166
0.039	0.008	0.017	0.025	0.034	0.042	0.050	0.059	0.067	0.076	0.084	0.092	0.101	0.109	0.118	0.126	0.134	0.143	0.151	0.160	0.168
0.040	0.009	0.017	0.026	0.034	0.043	0.051	0.060	0.068	0.077	0.085	0.094	0.102	0.111	0.119	0.128	0.136	0.145	0.153	0.162	0.170
0.041	0.009	0.017	0.026	0.035	0.043	0.052	0.060	0.069	0.078	0.086	0.095	0.104	0.112	0.121	0.130	0.138	0.147	0.156	0.164	0.173
0.042	0.009	0.018	0.026	0.035	0.044	0.053	0.061	0.070	0.079	0.088	0.096	0.105	0.114	0.123	0.131	0.140	0.149	0.158	0.166	0.175
0.043	0.009	0.018	0.027	0.036	0.044	0.053	0.062	0.071	0.080	0.089	0.098	0.107	0.115	0.124	0.133	0.142	0.151	0.160	0.169	0.178
0.044	0.009	0.018	0.027	0.036	0.045	0.054	0.063	0.072	0.081	0.090	0.099	0.108	0.117	0.126	0.135	0.144	0.153	0.162	0.171	0.180

Ls/L	H/L																			
	0.010	0.020	0.030	0.040	0.050	0.060	0.070	0.080	0.090	0.100	0.110	0.120	0.130	0.140	0.150	0.160	0.170	0.180	0.190	0.200
0.045	0.009	0.018	0.027	0.037	0.046	0.055	0.064	0.073	0.082	0.091	0.100	0.109	0.118	0.128	0.137	0.146	0.155	0.164	0.173	0.182
0.046	0.009	0.018	0.028	0.037	0.046	0.055	0.065	0.074	0.083	0.092	0.102	0.111	0.120	0.129	0.138	0.148	0.157	0.166	0.175	0.185
0.047	0.009	0.019	0.028	0.038	0.047	0.056	0.065	0.075	0.084	0.093	0.103	0.112	0.121	0.131	0.140	0.150	0.159	0.168	0.178	0.187
0.048	0.009	0.019	0.028	0.038	0.047	0.057	0.066	0.076	0.085	0.095	0.104	0.114	0.123	0.132	0.142	0.151	0.161	0.170	0.180	0.189
0.049	0.010	0.019	0.029	0.039	0.048	0.057	0.067	0.077	0.086	0.096	0.105	0.115	0.124	0.134	0.144	0.153	0.163	0.172	0.182	0.191
0.050	0.010	0.020	0.029	0.039	0.048	0.058	0.068	0.077	0.087	0.097	0.107	0.116	0.126	0.136	0.145	0.155	0.165	0.174	0.184	0.194
0.051	0.010	0.020	0.030	0.040	0.049	0.059	0.069	0.078	0.088	0.098	0.108	0.118	0.127	0.137	0.147	0.157	0.167	0.176	0.186	0.196
0.052	0.010	0.020	0.030	0.040	0.050	0.059	0.069	0.079	0.089	0.099	0.109	0.119	0.129	0.139	0.149	0.159	0.169	0.178	0.188	0.198
0.053	0.010	0.020	0.030	0.040	0.050	0.060	0.070	0.080	0.090	0.100	0.110	0.120	0.130	0.140	0.150	0.160	0.170	0.180	0.190	0.200
0.054	0.010	0.020	0.030	0.041	0.051	0.061	0.071	0.081	0.091	0.101	0.111	0.122	0.132	0.142	0.152	0.162	0.172	0.182	0.193	0.203
0.055	0.010	0.020	0.031	0.041	0.051	0.061	0.072	0.082	0.092	0.102	0.113	0.123	0.133	0.143	0.154	0.164	0.174	0.184	0.195	0.205
0.056	0.010	0.021	0.031	0.041	0.052	0.062	0.072	0.083	0.093	0.104	0.114	0.124	0.135	0.145	0.155	0.166	0.176	0.186	0.197	0.207
0.057	0.010	0.021	0.031	0.042	0.052	0.063	0.073	0.084	0.094	0.105	0.115	0.126	0.136	0.147	0.157	0.167	0.178	0.188	0.199	0.209
0.058	0.011	0.021	0.032	0.042	0.053	0.063	0.074	0.085	0.095	0.106	0.116	0.127	0.137	0.148	0.159	0.169	0.180	0.190	0.201	0.212
0.059	0.011	0.021	0.032	0.043	0.053	0.064	0.075	0.085	0.096	0.107	0.118	0.128	0.139	0.150	0.160	0.171	0.182	0.192	0.203	0.214
0.060	0.011	0.022	0.032	0.043	0.054	0.065	0.076	0.086	0.097	0.108	0.119	0.130	0.140	0.151	0.162	0.173	0.184	0.194	0.205	0.216
0.061	0.011	0.022	0.033	0.044	0.055	0.065	0.076	0.087	0.098	0.109	0.120	0.131	0.142	0.153	0.164	0.174	0.185	0.196	0.207	0.218
0.062	0.011	0.022	0.033	0.044	0.055	0.066	0.077	0.088	0.099	0.110	0.121	0.132	0.143	0.154	0.165	0.176	0.187	0.198	0.209	0.220
0.063	0.011	0.022	0.033	0.044	0.056	0.067	0.078	0.089	0.100	0.111	0.122	0.133	0.145	0.156	0.167	0.178	0.189	0.200	0.211	0.222
0.064	0.011	0.022	0.034	0.045	0.056	0.067	0.079	0.090	0.101	0.112	0.123	0.135	0.146	0.157	0.168	0.180	0.191	0.202	0.213	0.225
0.065	0.011	0.023	0.034	0.045	0.057	0.068	0.079	0.091	0.102	0.113	0.125	0.136	0.147	0.159	0.170	0.181	0.193	0.204	0.215	0.227
0.066	0.011	0.023	0.034	0.046	0.057	0.069	0.080	0.092	0.103	0.114	0.126	0.137	0.149	0.160	0.172	0.183	0.195	0.206	0.217	0.229
0.067	0.012	0.023	0.035	0.046	0.058	0.069	0.081	0.092	0.104	0.115	0.127	0.139	0.150	0.162	0.173	0.185	0.196	0.208	0.219	0.231
0.068	0.012	0.023	0.035	0.047	0.058	0.070	0.082	0.093	0.105	0.117	0.128	0.140	0.152	0.163	0.175	0.186	0.198	0.210	0.221	0.233
0.069	0.012	0.024	0.035	0.047	0.059	0.071	0.082	0.094	0.106	0.118	0.129	0.141	0.153	0.165	0.176	0.188	0.200	0.212	0.223	0.235
0.070	0.012	0.024	0.036	0.047	0.059	0.071	0.083	0.095	0.107	0.119	0.131	0.142	0.154	0.166	0.178	0.191	0.202	0.214	0.225	0.237
0.071	0.012	0.024	0.036	0.048	0.060	0.072	0.084	0.096	0.108	0.120	0.132	0.144	0.156	0.168	0.180	0.192	0.204	0.216	0.227	0.239
0.072	0.012	0.024	0.036	0.048	0.060	0.072	0.085	0.097	0.109	0.121	0.133	0.145	0.157	0.169	0.181	0.193	0.205	0.217	0.229	0.242
0.073	0.012	0.024	0.037	0.049	0.061	0.073	0.085	0.097	0.110	0.122	0.134	0.146	0.158	0.171	0.183	0.195	0.207	0.219	0.232	0.244
0.074	0.012	0.025	0.037	0.049	0.061	0.074	0.086	0.098	0.111	0.123	0.135	0.147	0.160	0.172	0.184	0.197	0.209	0.221	0.234	0.246
0.075	0.012	0.025	0.037	0.050	0.062	0.074	0.087	0.099	0.112	0.124	0.136	0.149	0.161	0.174	0.186	0.198	0.211	0.223	0.236	0.248
0.076	0.012	0.025	0.037	0.050	0.062	0.075	0.087	0.100	0.112	0.125	0.137	0.150	0.162	0.175	0.187	0.200	0.212	0.225	0.237	0.250
0.077	0.013	0.025	0.038	0.050	0.063	0.076	0.088	0.101	0.113	0.126	0.139	0.151	0.164	0.176	0.189	0.202	0.214	0.227	0.239	0.252
0.078	0.013	0.025	0.038	0.051	0.064	0.076	0.089	0.102	0.114	0.127	0.140	0.153	0.165	0.178	0.191	0.203	0.216	0.229	0.241	0.254
0.079	0.013	0.026	0.038	0.051	0.064	0.077	0.090	0.103	0.115	0.128	0.141	0.154	0.167	0.179	0.192	0.205	0.218	0.231	0.243	0.256
0.080	0.013	0.026	0.039	0.052	0.065	0.078	0.090	0.103	0.116	0.129	0.142	0.155	0.168	0.181	0.194	0.207	0.220	0.233	0.245	0.258
0.081	0.013	0.026	0.039	0.052	0.065	0.078	0.091	0.104	0.117	0.130	0.143	0.156	0.169	0.182	0.195	0.208	0.221	0.234	0.247	0.260
0.082	0.013	0.026	0.039	0.053	0.066	0.079	0.092	0.105	0.118	0.131	0.144	0.158	0.171	0.184	0.197	0.210	0.223	0.236	0.249	0.263
0.083	0.013	0.026	0.040	0.053	0.066	0.079	0.093	0.106	0.119	0.132	0.146	0.159	0.172	0.185	0.198	0.212	0.225	0.238	0.251	0.265
0.084	0.013	0.027	0.040	0.053	0.067	0.080	0.093	0.107	0.120	0.133	0.147	0.160	0.173	0.187	0.200	0.213	0.227	0.240	0.253	0.267
0.085	0.013	0.027	0.040	0.054	0.067	0.081	0.094	0.108	0.121	0.134	0.148	0.161	0.175	0.188	0.202	0.215	0.228	0.242	0.255	0.269
0.086	0.014	0.027	0.041	0.054	0.068	0.081	0.095	0.108	0.122	0.135	0.149	0.163	0.176	0.190	0.203	0.217	0.230	0.244	0.257	0.271

Ls/L	H/L																			
	0.010	0.020	0.030	0.040	0.050	0.060	0.070	0.080	0.090	0.100	0.110	0.120	0.130	0.140	0.150	0.160	0.170	0.180	0.190	0.200
0.087	0.014	0.027	0.041	0.055	0.068	0.082	0.096	0.109	0.123	0.136	0.150	0.164	0.177	0.191	0.205	0.218	0.232	0.246	0.259	0.273
0.088	0.014	0.028	0.041	0.055	0.069	0.083	0.096	0.110	0.124	0.138	0.151	0.165	0.179	0.193	0.206	0.220	0.234	0.248	0.261	0.275
0.089	0.014	0.028	0.042	0.055	0.069	0.083	0.097	0.111	0.125	0.139	0.152	0.166	0.180	0.194	0.208	0.222	0.236	0.249	0.263	0.277
0.090	0.014	0.028	0.042	0.056	0.070	0.084	0.098	0.112	0.126	0.140	0.154	0.168	0.181	0.195	0.209	0.223	0.237	0.251	0.265	0.279
0.091	0.014	0.028	0.042	0.056	0.070	0.084	0.098	0.113	0.127	0.141	0.155	0.169	0.183	0.197	0.211	0.225	0.239	0.253	0.267	0.281
0.092	0.014	0.028	0.043	0.057	0.071	0.085	0.099	0.113	0.128	0.142	0.156	0.170	0.184	0.198	0.213	0.227	0.241	0.255	0.269	0.283
0.093	0.014	0.029	0.043	0.057	0.071	0.086	0.100	0.114	0.128	0.143	0.157	0.171	0.186	0.200	0.214	0.228	0.243	0.257	0.271	0.285
0.094	0.014	0.029	0.043	0.058	0.072	0.086	0.101	0.115	0.129	0.144	0.158	0.173	0.187	0.201	0.216	0.230	0.244	0.259	0.273	0.288
0.095	0.014	0.029	0.043	0.058	0.072	0.087	0.101	0.116	0.130	0.145	0.159	0.174	0.188	0.203	0.217	0.232	0.246	0.261	0.275	0.290
0.096	0.015	0.029	0.044	0.058	0.073	0.088	0.102	0.117	0.131	0.146	0.160	0.175	0.190	0.204	0.219	0.233	0.248	0.263	0.277	0.292
0.097	0.015	0.029	0.044	0.059	0.073	0.088	0.103	0.118	0.132	0.147	0.162	0.176	0.191	0.206	0.220	0.235	0.250	0.264	0.279	0.294
0.098	0.015	0.030	0.044	0.059	0.074	0.089	0.104	0.118	0.133	0.148	0.163	0.178	0.192	0.207	0.222	0.237	0.251	0.266	0.281	0.296
0.099	0.015	0.030	0.045	0.060	0.074	0.089	0.104	0.119	0.134	0.149	0.164	0.179	0.194	0.209	0.223	0.238	0.253	0.268	0.283	0.298
0.100	0.015	0.030	0.045	0.060	0.075	0.090	0.105	0.120	0.135	0.150	0.165	0.180	0.195	0.210	0.225	0.240	0.255	0.270	0.285	0.300

3. Methods of Atk – Simply Supported Spans

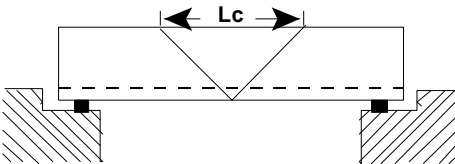
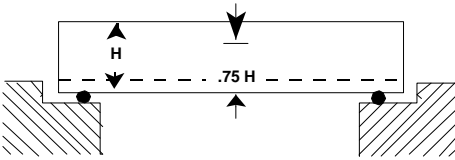
SER	SUB-CATEGORY	TYPE	METHOD OF ATK	REMARKS
(a)	(b)	(c)	(d)	(e)
1	Steel beam	Through br I	<p><u>Top Atk</u></p>  <p>1. Cut at mid-span 2. Cut beams incl bottom flange in "V" 3. Deck need NOT be cut</p>	
2	Steel beam	Through br II	<p><u>Bottom atk E is greater than E_R</u></p> 	

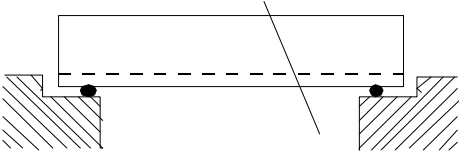
SER	SUB-CATEGORY	TYPE	METHOD OF ATK	REMARKS
(a)	(b)	(c)	(d)	(e)
3	Steel beam	Through br III	<p>1. Cut at mid-span to depth 0.75 H as shown 2. Deck must be cut across full width of br</p> <p><u>Angled atk</u></p>  <p>The diagram shows a cross-section of a steel beam supported by two hatched abutments. A dashed line represents the original deck level. A solid line shows the deck after being cut at an angle. A diagonal line indicates the cut angle, which is approximately 70 degrees to the beam flange. The cut is located between the 1/3 span and mid-span.</p> <p>1. Cut between 1/3 span and mid-span 2. Cut angle at approx 70° to beam flange 3. Deck must be cut across full width of br</p>	End clr is NOT a consideration
4	Steel beam	Through br IV	<p><u>Bottom Atk E is less than E_R</u></p> <p>1. Cut at mid-span to depth 0.75 H as shown in Ser 2 2. Deck must be cut across full width of br 3. Atk the end of the br or one pier/abutment to create sufficient end clr</p>	

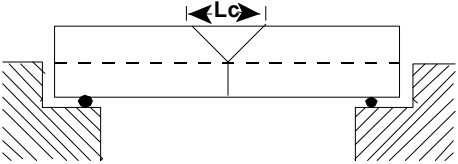
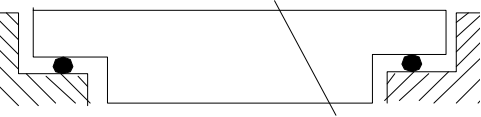
SER	SUB-CATEGORY	TYPE	METHOD OF ATK	REMARKS
(a)	(b)	(c)	(d)	(e)
5	Steel beam	Through br V (Where deck is loc well above the level of the bottom of the beams)	<p>Top Atk E is less than E_R</p>  <ol style="list-style-type: none"> Cut at mid-span Use cuts as shown Deck need NOT be cut 	
6	Steel beam	Deck br top sp	<p>Angled Atk</p>  <ol style="list-style-type: none"> Cut between 1/3 span and mid-span 	<ol style="list-style-type: none"> Found in cantilever and suspended span br End clr is NOT a consideration

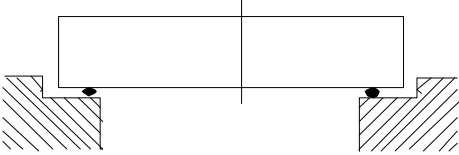
SER	SUB-CATEGORY	TYPE	METHOD OF ATK	REMARKS
(a)	(b)	(c)	(d)	(e)
			2. Cut entire beam at approx 70° to beam flange 3. Deck must be cut across full width of br	
7	Steel beam	Deck br bottom sp I	<p><u>Bottom Atk E is greater than E_R</u></p>  <p>1. Cut at mid-span 2. Cut full depth of web and both flanges 3. Deck need NOT be cut</p>	
8	Steel beam	Deck br bottom sp II	<p><u>Bottom Atk E is less than E_R</u></p> <p>1. Cut at mid-span 2. Cut full depth of web and both flanges 3. Atk the end of the br or one abutment/pier to create sufficient end clr 4. Deck need NOT be cut</p>	

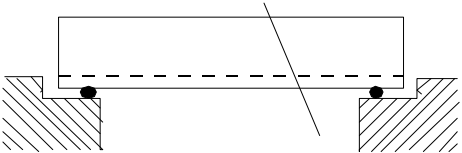
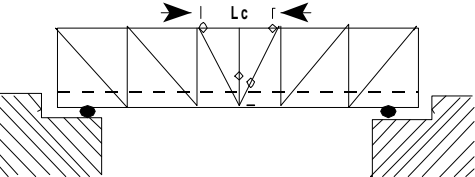
SER	SUB-CATEGORY	TYPE	METHOD OF ATK	REMARKS
(a)	(b)	(c)	(d)	(e)
9	Steel beam	Deck br bottom sp III	<p><u>Angled Atk</u></p>  <ol style="list-style-type: none"> 1. Cut between 1/3 span and mid-span 2. Cut entire beam at approx 70° to beam flange 3. Deck must be cut across full width of br 	End clr is NOT a consideration
10	Steel truss	Through br I	<p><u>Top Atk E is less than E_R</u></p>  <ol style="list-style-type: none"> 1. Cut at mid-span 	

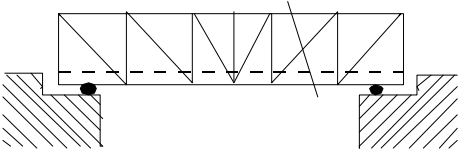
SER	SUB-CATEGORY	TYPE	METHOD OF ATK	REMARKS
(a)	(b)	(c)	(d)	(e)
			2. Cut top chord twice, vertical (if nec), diagonal and bottom chord 3. Wind bracing at top chord level must be removed over L_c 4. Deck need NOT be cut	
11	Steel truss	Through br II	<u>Angled Atk</u>  <ol style="list-style-type: none"> 1. Cut between 1/3 span and mid-span 2. Cut top chord, diagonals and bottom chord in one bay only. Cut is to be angled at 70° to top chord 3. Deck must be cut across full width of br 	

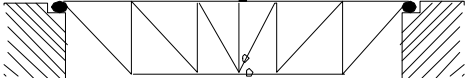
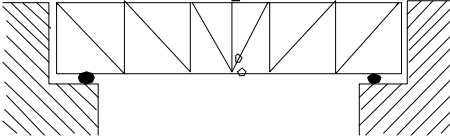
SER	SUB-CATEGORY	TYPE	METHOD OF ATK	REMARKS
(a)	(b)	(c)	(d)	(e)
12	Steel truss	Deck br top sp	<p data-bbox="578 223 708 244"><u>Bottom Atk</u></p>  <ol data-bbox="578 498 1187 614" style="list-style-type: none"> 1. Cut at mid-span 2. Cut top chord, diagonals and bottom chord in one bay only 3. Deck need NOT be cut 	
13	Steel truss	Deck br bottom sp I	<p data-bbox="578 624 922 645"><u>Bottom Atk E is greater than E_R</u></p> 	

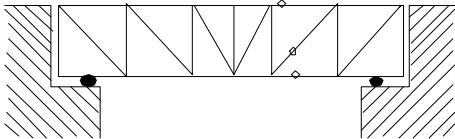
SER	SUB-CATEGORY	TYPE	METHOD OF ATK	REMARKS
(a)	(b)	(c)	(d)	(e)
			<ol style="list-style-type: none"> 1. Cut at mid-span 2. Cut top chord, diagonals and bottom chord in one bay only 3. Deck need NOT be cut 	
14	Steel truss	Deck br bottom sp II	<p><u>Bottom Atk E is Less than E_R</u></p> <ol style="list-style-type: none"> 1. Cut at mid-span. 2. Cut top chord, diagonals and bottom chord in one bay only. 3. Atk the end of the br or one pier/abutment to create sufficient end clr 4. Deck need NOT be cut 	
15	Steel truss	Deck br bottom sp III	<p><u>Angled Atk</u></p>  <ol style="list-style-type: none"> 1. Cut between 1/3 span and mid-span 2. Cut angled at approx 70° to top chord 	End clr is NOT a consideration

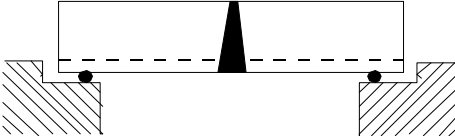
SER	SUB-CATEGORY	TYPE	METHOD OF ATK	REMARKS
(a)	(b)	(c)	(d)	(e)
			3. Deck must be cut across full width of br 4. Cut top chord diagonals and bottom chord in one bay only	
16	Concrete	Through br	<p><u>Bottom Atk</u></p>  <p>1. Cut at mid-span 2. Complete cut through beam 3. Deck must be cut across full width of br</p>	
17	Concrete	Deck br top sp	<u>Top Atk</u>	1. Found in cantilever and suspended span br 2. Remove concrete over length L_C to full width and depth of beams

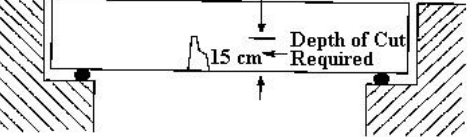
SER	SUB-CATEGORY	TYPE	METHOD OF ATK	REMARKS
(a)	(b)	(c)	(d)	(e)
			 <p>Atk at mid-span using concrete stripping charge</p>	
18	Concrete	Deck br bottom sp	<p>Bottom Atk, E is greater than E_R</p>  <p>Cut at mid-span</p>	<ol style="list-style-type: none"> 1. Applies to <u>slab bridges only</u> 2. This cuts sufficient reinforcing bars in reinforced concrete <u>slabs</u> to cause collapse
19	Concrete	Deck br bottom sp II	<p>Bottom Atk E is less than E_R</p> <ol style="list-style-type: none"> 1. Cut at mid-span 2. Atk the end of the br or one pier/abutment to create sufficient end clr 	<ol style="list-style-type: none"> 1. Applies to <u>slab br only</u> 2. Same as above

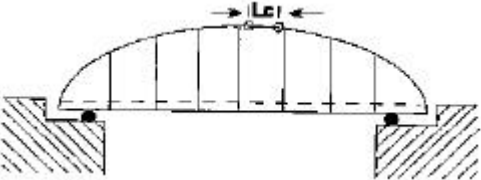
SER	SUB-CATEGORY	TYPE	METHOD OF ATK	REMARKS
(a)	(b)	(c)	(d)	(e)
20	Concrete	Deck br bottom sp III	<p>Top Atk E is less than E_R</p>  <p>Atk at mid span using concrete stripping charge</p>	<p>Remove concrete over length L_C to full width and depth of beams. Plan for a two-stage atk to cut the anchor span although failure may occur after the first stage.</p>
21	Bowstring	Normal	<p>Top Atk</p>  <ol style="list-style-type: none"> 1. Cut at mid-span 2. Cut bow in two places 3. Cut any hangers between bow cuts 4. Deck need NOT be cut 	

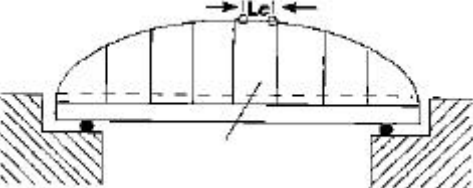
SER	SUB-CATEGORY	TYPE	METHOD OF ATK	REMARKS
(a)	(b)	(c)	(d)	(e)
22	Bowstring	Reinforced	<p data-bbox="578 223 797 249">Top Atk plus girders</p>  <ol data-bbox="578 508 1170 655" style="list-style-type: none"> 1. Cut at mid-span 2. Cut bow in two places 3. Cut any hangers between bow cuts 4. Deck need NOT be cut 5. Cut longitudinal reinforcing beams/trusses as shown 	

805.38 - METHODS OF ATK FOR CONTINUOUS SPANS

1. Recce Measurements

H/L	L_c/L	H/L	L_c/L
0.04	0.003	0.22	0.10
0.06	0.007	0.24	0.13
0.08	0.013	0.26	0.15
0.10	0.02	0.28	0.17
0.12	0.03	0.30	0.20
0.14	0.04	0.32	0.23
0.16	0.053	0.34	0.27
0.18	0.067	0.36	0.30
0.20	0.083		

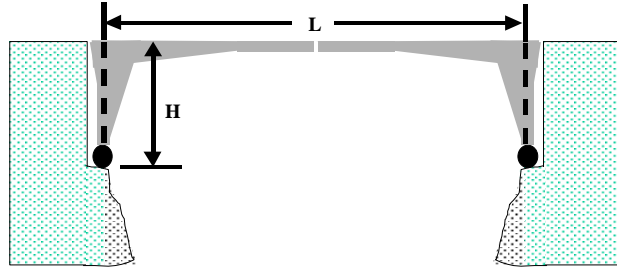

H is the rise and L the span between bearings. For arch and pinned footing portal bridges calculate L_c by determining H/L and then L_c/L , and hence L_c from the supporting table. Interpolate as necessary.

2. Method of Atk – Continuous Spans

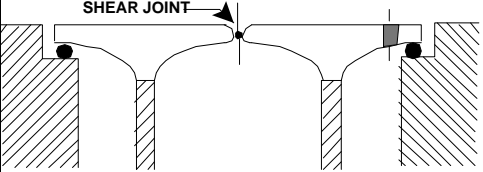
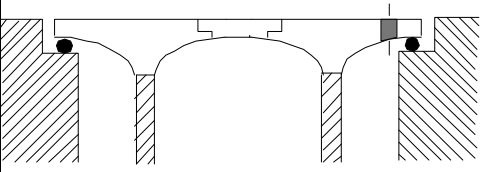
SER	SUB-CATEGORY	TYPE	METHOD OF ATK	REMARKS
(a)	(b)	(c)	(d)	(e)
1	Concrete	Cantilever	<p><u>Two Complete Cuts</u></p>  <p>1. Cut anchor span as near pier as practical 2. Cut mid-span shear joint</p>	<p>1. Plan for a two-stage atk to cut the anchor span although failure may occur after the first stage 2. Use concrete stripping charge for first stage</p>
2	Concrete	Cantilever and suspended span	<p><u>One Complete Cut</u></p> 	<p>Plan for a two-stage atk to cut the anchor span although failure may occur after the first stage. Use concrete stripping charge for first stage. If dml of the suspended span alone will create the desired obs, regard the suspended span as a simply supported br, then categorize and atk accordingly</p>

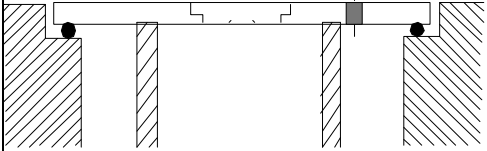
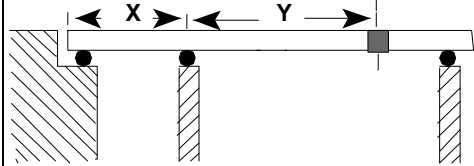
SER	SUB-CATEGORY	TYPE	METHOD OF ATK	REMARKS
(a)	(b)	(c)	(d)	(e)
			 <p data-bbox="560 471 982 497">Cut anchor span as near pier as practical</p>	
3	Concrete	Beam/truss with short side span	<p data-bbox="560 512 755 533"><u>One Complete Cut</u></p>  <ol data-bbox="560 782 1161 844" style="list-style-type: none"> 1. Cut interior span so that Y is greater than 1.25X 2. If nec cut other interior spans as in Ser 4 	<p data-bbox="1177 512 1526 657">Plan for a two-stage atk to cut the longer span although failure may occur after the first stage. Use concrete stripping charge for first stage</p>

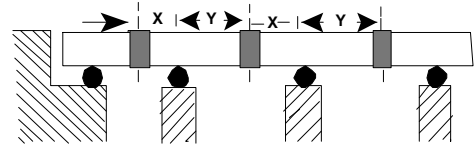
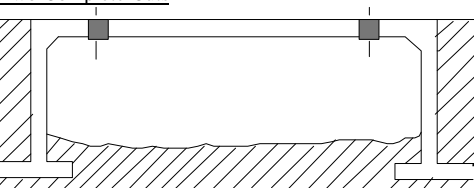
SER	SUB-CATEGORY	TYPE	METHOD OF ATK	REMARKS
(a)	(b)	(c)	(d)	(e)
4	Concrete	Beam/truss, without short span	<p><u>Two or More Complete Cuts</u></p>  <p>Cut span so that Y is greater than 1.25X</p>	Plan for a two stage at although failure may occur after the first stage. Use concrete stripping charge to achieve first stage
5	Concrete	Portal, fixed footing	<p><u>Two Complete Cuts</u></p>  <p>Cut span twice close to piers</p>	<ol style="list-style-type: none"> 1. Plan for a two-stage atk although failure may occur after the first stage. 2. Use concrete stripping charge to achieve first stage

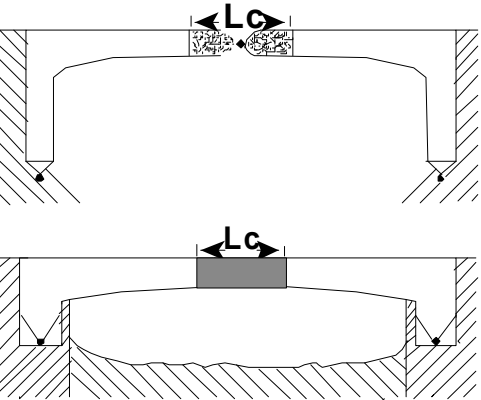
SER	SUB-CATEGORY	TYPE	METHOD OF ATK	REMARKS
(a)	(b)	(c)	(d)	(e)
6	Concrete	Portal, pinned footing	<p data-bbox="561 228 789 254">Stripping of Concrete</p>  <p data-bbox="561 803 1130 855">Remove concrete from mid-span over length L_c using concrete stripping charge</p>	<ol style="list-style-type: none"> <li data-bbox="1179 228 1520 317">1. Plan for a two stage at although failure may occur after the first stage <li data-bbox="1179 322 1520 410">2. When footing conditions are unk, method of atk <u>must be</u> as for Ser 5

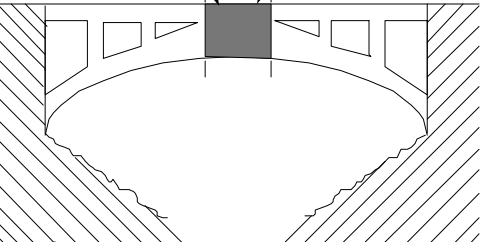
SER	SUB-CATEGORY	TYPE	METHOD OF ATK	REMARKS
(a)	(b)	(c)	(d)	(e)
7	Concrete	Arch, open spandrel, fixed footing	<p data-bbox="561 223 789 254">Stripping of Concrete</p>  <p data-bbox="561 627 1065 679">Remove concrete over length L_c, using concrete stripping charge</p>	<ol data-bbox="1179 223 1520 379" style="list-style-type: none"> 1. This applies to arches of span greater than 40 m only 2. Plan for a two-stage atk although failure may occur after the first stage

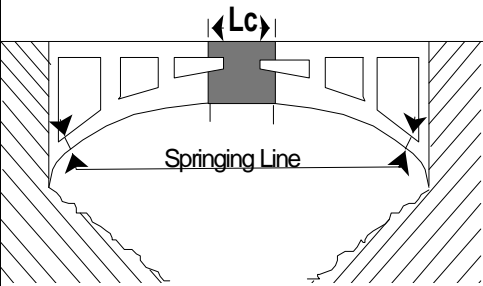
SER	SUB-CATEGORY	TYPE	METHOD OF ATK	REMARKS
(a)	(b)	(c)	(d)	(e)
8	Concrete	Arch, open spandrel, fixed footing II	<p><u>Stripping of Concrete</u></p>  <p>1. Remove concrete from midspan over length L_c using concrete stripping charge formula 2. Atk Springing Line against top face of arch ring</p>	<p>1. This applies to arches of span less than 40 m 2. Plan for a two-stage atk to cut the anchor span although failure may occur after the first stage</p>

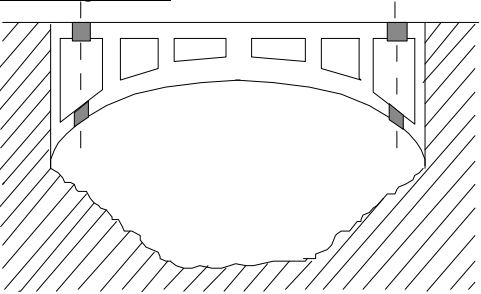
SER	SUB-CATEGORY	TYPE	METHOD OF ATK	REMARKS
(a)	(b)	(c)	(d)	(e)
9	Concrete	Arch, open spandrel, fixed footing III	<p data-bbox="560 227 779 253"><u>Four Complete Cuts</u></p> 	<ol style="list-style-type: none"> <li data-bbox="1177 227 1518 315">1. This method is an altn to Ser 8 and applies to arches of span less than 40 m <li data-bbox="1177 315 1518 409">2. Plan for a two-stage atk although failure may occur after the first stage <li data-bbox="1177 409 1518 471">3. Use concrete stripping charge to achieve first stage

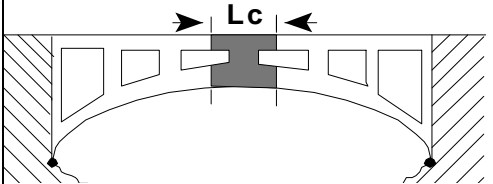
SER	SUB-CATEGORY	TYPE	METHOD OF ATK	REMARKS
(a)	(b)	(c)	(d)	(e)
10	Concrete	Arch, open spandrel, pinned footing	<p data-bbox="553 223 781 249"><u>Stripping of concrete</u></p>  <p data-bbox="553 627 1105 684">Remove all concrete over length L_c, using concrete stripping charge</p>	Plan for a two-stage atk although failure may occur after the first stage

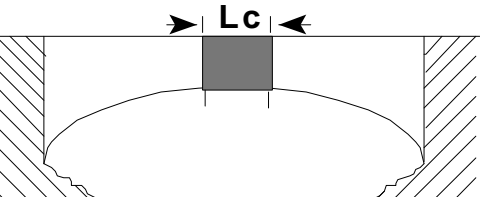
SER	SUB-CATEGORY	TYPE	METHOD OF ATK	REMARKS
(a)	(b)	(c)	(d)	(e)
11	Concrete	Arch, solid spandrel, fixed footing I	<p data-bbox="561 223 789 249"><u>Stripping of Concrete</u></p>  <p data-bbox="561 622 1122 679">Remove concrete from midspan over length L_c using concrete stripping charge</p>	<ol data-bbox="1179 223 1526 373" style="list-style-type: none"> 1. This applies to arches of span less than 40 m 2. Plan for a two-stage atk although failure may occur after the first stage

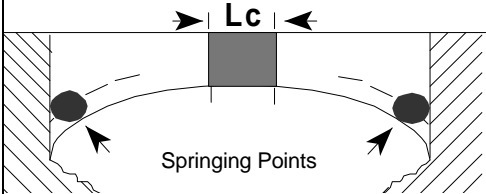
SER	SUB-CATEGORY	TYPE	METHOD OF ATK	REMARKS
(a)	(b)	(c)	(d)	(e)
12	Concrete	Arch, solid spandrel, fixed footing II	<p><u>Stripping of Concrete</u></p>  <p>1. Remove all concrete over length L_c. Atk both springing pts by removing concrete using concrete stripping charges either against bottom face of arch ring, or against top face of arch ring, having removed spandrel fill beneath roadway</p>	<p>1. This applies to arches of span less than 40 m</p> <p>2. Plan for a two-stage atk although failure may occur after the first stage</p>

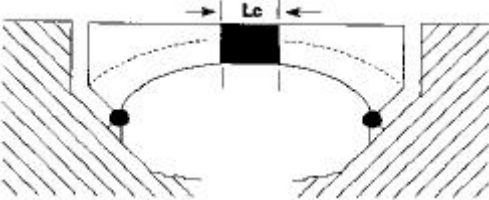
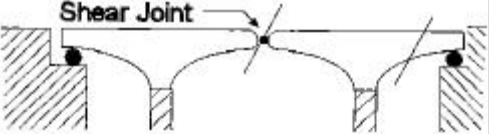
SER	SUB-CATEGORY	TYPE	METHOD OF ATK	REMARKS
(a)	(b)	(c)	(d)	(e)
13	Concrete	Arch, solid spandrel, pinned footing	<p>Stripping of Concrete</p>  <p>Remove all concrete over length L_C using the concrete stripping charge</p>	Plan for a two stage atk although failure may occur after the first stage
14	Steel	Cantilever	<p>Two Complete Cuts</p>  <p>Cut anchor span as near pier as practical Cut mid-span shear joint</p>	

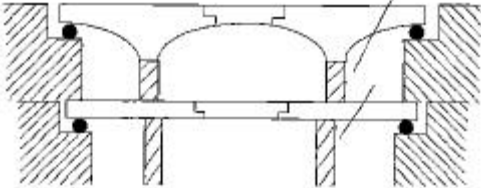
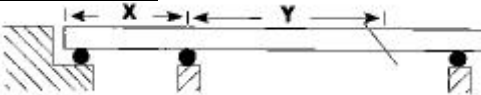
SER	SUB-CATEGORY	TYPE	METHOD OF ATK	REMARKS
(a)	(b)	(c)	(d)	(e)
15	Steel	Cantilever and suspended span	<p><u>One Complete Cut</u></p>  <p>Cut anchor span as near pier as practical</p>	If the dml of the suspended span alone will create the desired obs, regard the suspended span as a simply supported br, and categorize and atk accordingly
16	Steel	Beam/truss with short side span	<p><u>One Complete Cut</u></p>  <ol style="list-style-type: none"> 1. Cut interior span so that Y is greater than 1.25X 2. If nec, cut other interior spans as in Ser 17 	

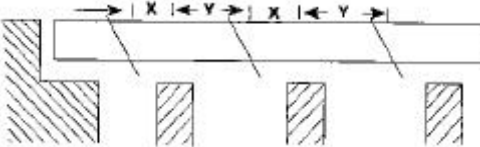
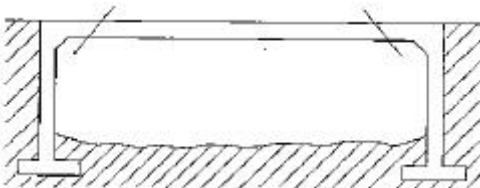
SER	SUB-CATEGORY	TYPE	METHOD OF ATK	REMARKS
(a)	(b)	(c)	(d)	(e)
17	Steel	Beam/truss without short side span	<p><u>Two or More Complete Cuts</u></p>  <p>Cut interior spans so that Y is greater than 1.25X</p>	
18	Steel	Portal, fixed footing	<p><u>Two Complete Cuts</u></p>  <p>Cut span twice close to piers</p>	

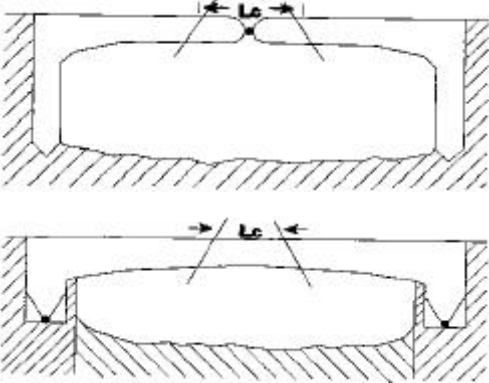
SER	SUB-CATEGORY	TYPE	METHOD OF ATK	REMARKS
(a)	(b)	(c)	(d)	(e)
19	Steel	Portal, pinned footing	<p><u>Two Complete Cuts</u></p>  <p>Remove sect from mid-span over length L_c</p>	When footing conditions are unk, use the method of atk in Ser 18

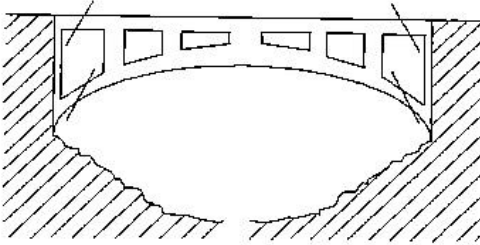
SER	SUB-CATEGORY	TYPE	METHOD OF ATK	REMARKS
(a)	(b)	(c)	(d)	(e)
20	Steel	Arch, open spandrel, fixed footing	<u>Four Complete Cuts</u>  A cross-sectional diagram of an arch bridge. The arch is supported by two abutments. The spandrel between the arch and the abutments is shown with four rectangular openings, each with a diagonal line through it, indicating a complete cut. The text 'Four Complete Cuts' is written above the diagram. The bridge is shown resting on a fixed footing, which is indicated by hatching on the ground level.	

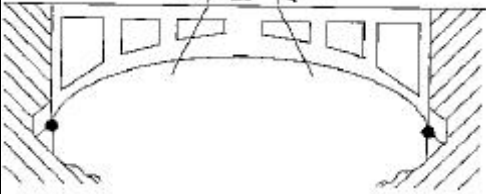
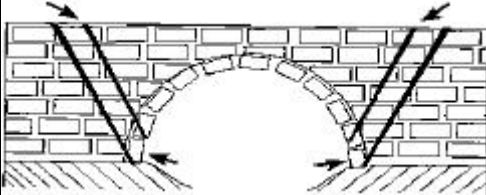
SER	SUB-CATEGORY	TYPE	METHOD OF ATK	REMARKS
(a)	(b)	(c)	(d)	(e)
21	Steel	Arch, open spandrel, pinned footing	<p>Two Complete Cuts</p>  <p>Remove sect from mid-span over length L_c</p>	
22	Masonry arch I		<p>Two Complete Cuts</p>  <p>Cut at haunches Arch ring, spandrel walls and parapet shall all be atk</p>	

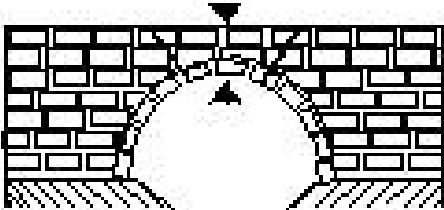
SER	SUB-CATEGORY	TYPE	METHOD OF ATK	REMARKS
(a)	(b)	(c)	(d)	(e)
23	Masonry, arch II		<p data-bbox="553 221 760 249"><u>One Complete Cut</u></p>  <p data-bbox="553 529 834 558">Breach arch ring at crown</p>	Use this method as an altrn to Ser 22 only when time is insufficient to allow atk at haunches

805.39 - DEMOLITIONS - GENERAL

1. Outline Planning Data

Ser	Const	Span (m)	Width (m)	Cut One Span			One Pier			One Abutment		
				Sect	Time (hr)	Expl (kg)	Sect	Time (hr)	Expl (kg)	Sect	Time (hr)	Expl (kg)
(a)	(b)	(c)	(d)	(e)	(f)	(g)	(h)	(i)	(j)	(k)	(l)	(m)
1	Brick or masonry and mass concrete arches, piers, and abutments	3-12	To 6	1	4	36	1	3	35	1	2	65
		12-24	To 6	1	5	64	1	4	60	1	2	65
		3-12	6-12	1	6	75	1	5	70	1	2	100
		12-24	6-12	2	6	130	1	6	100	1	2	100
2	Steel girder spans, mass concrete piers and abutments	3-12	To 6	1	4	27	1	2.5	35	1	2	65
		12-24	To 6	1	5	68	1	3	100	1	2	65
		24-40	To 6	1	6	130	1	3.5	70	1	2	65
		3-12	6-12	1	4	54	1	3	70	1	2	100
		12-24	6-12	1	6	135	1	3.5	100	1	2	100
		24-40	6-12	2	6	200	1	3.5	100	1	2	100

Insert – Engineers

Ser	Const	Span (m)	Width (m)	Cut One Span			One Pier			One Abutment		
				Sect	Time (hr)	Expl (kg)	Sect	Time (hr)	Expl (kg)	Sect	Time (hr)	Expl (kg)
(a)	(b)	(c)	(d)	(e)	(f)	(g)	(h)	(i)	(j)	(k)	(l)	(m)
3	Steel girder spans, mass concrete piers and abutments	3-12	To 6	1	4	75	1	3	45	1	2	70
		12-24	To 6	1	5	160	1	4	70	1	2	70
		24-40	To 6	1	6	225	1	5	120	1	2	70
		3-12	6-12	2	4	145	2	4	90	1	2	100
		12-24	6-12	2	5	320	2	5	140	1	2	100
		24-40	6-12	2	6	445	2	6	230	1	2	100
4	RC arches, piers and abutments	3-12	To 6	2	8	230	Piers probably too thick to atk			Abutments probably too hy for camouflet charges		
		12-24	To 6	2	12	365						
		24-40	To 6	2	16	455						
		3-12	6-12	3	12	455						
		12-24	6-12	3	16	725						
		24-40	6-12	3	20	1090						

2. **Rd Cratering**

Ser	Method of Atk	Time (hrs)	Remarks
(a)	(b)	(c)	(d)
1	Camouflet	2 - 4.5	1. Each craters normally mined with 5 AT mines
2	Shaped Charge	2.5 - 5	2. Nine craters will take approx four X sect hrs to mine and record
3	Power Auger	1.5 - 3	3. Timings are for sect hrs

3. **Calculation of Charges**a. **Dimensions of C4 expl:**

- (1) Block length is 27.94 cm rounded to **28 cm**.
- (2) Block width is 5.08 cm rounded to **5 cm**.
- (3) Block thickness is 2.54 cm rounded to **2.5 cm**.
- (4) Block wt is 0.558 kg rounded to **0.56 kg**.
- (5) Block vol is **350 cm³**.

b. **Rounding Off/Up.** The fol rules apply:

- (1) all calculations in a given formula should be done in **cm or m, and kg**,
- (2) rounding off to **two decimal places** should be done **at each step of a calculation**,
- (3) conversion from kg to blocks of C4 is accomplished by dividing answers in kg by 0.56 (wt of a block of C4),
- (4) then rounding to the nearest quarter block, and
- (5) all charge calculations are then totalled for the qty of expl reqr for the task. At the final stage (ie. sqn level), the final charge qty is calculated by adding an extra 10% to compensate for charge placement and waste.

c. All tables in this Aide-Memoire are tabular answers, based on deliberate formulas.

- d. The rule in charge calculation is to round up to the nearest quarter block and when calculating charge end cross sect (Cx), Cx will not be less than one.
- e. Cx is already calculated using tabular tables.

805.40 - CUTTING CHARGES FOR ROUND STEEL BAR AND STEEL WIRE ROPE

Round Steel Bar Circumference (cm)	Blocks Of C4	High Carbon/ Alloy Steel Bar Circumference (cm)	Blocks Of C4	Steel Wire Rope Circumference (cm)	Blocks Of C4	High Carbon/ Alloy Steel Wire Rope Circumference (cm)	Blocks Of C4
8.9	0.25	5.6	0.25	8.0	0.25	5.1	0.25
12.5	0.5	7.9	0.5	11.3	0.5	7.1	0.5
15.2	0.75	9.6	0.75	13.8	0.75	8.7	0.75
17.6	1	11.1	1	15.9	1	10	1
19.6	1.25	12.4	1.25	17.8	1.25	11.2	1.25
21.5	1.5	13.6	1.5	19.4	1.5	12.3	1.5
23.2	1.75	14.7	1.75	21.0	1.75	13.3	1.75
24.8	2	15	2	22.4	2	14.2	2
26.3	2.25			23.8	2.25	15	2.25
27.7	2.5			25.1	2.5		
29.1	2.75			26.3	2.75		

Round Steel Bar Circumference (cm)	Blocks Of C4	High Carbon/ Alloy Steel Bar Circumference (cm)	Blocks Of C4	Steel Wire Rope Circumference (cm)	Blocks Of C4	High Carbon/ Alloy Steel Wire Rope Circumference (cm)	Blocks Of C4
30.4	3			27.5	3	The calculation formulas below give most structural and cable steels up to 3.14-cm circumference (1.0-cm dia). Use shaped charges for circumferences larger than 3.14 cm.	
31.4	3.25			28.6	3.25		
				29.7	3.5		
				30.7	3.75		
				31.4	4		

1. **Calculation**

- a. Steel Bars $C = C^2/550$
- b. Steel Cables $C = C^2/450$
- c. Steel Chains $C = C^2/550$

NOTE: Sub-paragraph a and c can be used against high carbon steel and alloy tgts up to 15 cm in circumference and must be then multiplied by 2.5.

805.41 - CUTTING CHARGES FOR RECTANGULAR TIMBER**1. Cutting Charge Rectangular Timber Charge End Cross Sect For Blocks of C4**

TIMBER THICKNESS (cm)	C _x (C4)	TIMBER THICKNESS (cm)	C _x (C4)	TIMBER THICKNESS (cm)	C _x (C4)
29	1	52.2	3.25	68.0	5.5
32.4	1.25	54.2	3.5	69.5	5.75
35.5	1.5	56.1	3.75	71.0	6
38.3	1.75	58.0	4	72.4	6.25
41.0	2	59.7	4.25	73.9	6.5
43.5	2.25	61.5	4.5	75.3	6.75
45.8	2.5	63.1	4.75	76.7	7
48.1	2.75	64.8	5		
50.2	3	66.4	5.25		

a. **Charge Calculation.** Charges used for cutting rectangular timber can be calculated using the fol formula:

$C_x = \frac{T^2}{42000} \times \frac{\text{Length Of Block (cm)}}{\text{Weight of block (kg)}}$ $C = \frac{\text{LC (cm)}}{\text{length of block}} \times C_x$	Where C _x = The Charge End Cross Sect T = The Thickness Of The Target (cm) C = Charge Reqr (Blocks Of C4) LC = Length Of Cut (cm)
NOTE: The above table has already calculated C _x (C4) for thickness (cm) mentioned.	

2. Cutting Charge For Round Timber/Abatis in Blocks of C4

Round Timber Circumference (cm)	Blocks of C4	Round Timber Circumference (cm)	Blocks of C4	Round Timber Circumference (cm)	Blocks of C4
51.9	0.25	164.8	8.25	206.6	16.25
65.1	0.5	166.5	8.5	207.6	16.5
74.3	0.75	168.1	8.75	208.7	16.75
81.8	1	169.7	9	209.7	17
88	1.25	171.2	9.25	210.7	17.25
93.5	1.5	172.7	9.5	211.7	17.5
98.4	1.75	174.2	9.75	212.7	17.75
102.9	2	175.7	10	213.7	18
107	2.25	177.2	10.25	214.7	18.25
110.8	2.5	178.6	10.5	215.7	18.5
114.3	2.75	180	10.75	216.7	18.75
117.7	3	181.4	11	217.6	19
120.9	3.25	182.8	11.25	218.6	19.25
123.9	3.5	184.1	11.5	219.5	19.5
126.8	3.75	185.4	11.75	220.5	19.75
129.5	4	186.7	12	221.4	20
132.2	4.25	188	12.25	222.3	20.25
134.7	4.5	189.3	12.5	223.2	20.5
137.1	4.75	190.5	12.75	224.1	20.75

Round Timber Circumference (cm)	Blocks of C4	Round Timber Circumference (cm)	Blocks of C4	Round Timber Circumference (cm)	Blocks of C4
139.5	5	191.8	13	225	21
141.8	5.25	193	13.25	225.9	21.25
144	5.5	194.2	13.5	226.8	21.5
146.1	5.75	195.4	13.75	227.7	21.75
148.2	6	196.6	14	228.5	22
150.3	6.25	197.7	14.25	229.4	22.25
152.2	6.5	198.9	14.5	230.2	22.5
154.2	6.75	200	14.75	231.1	22.75
156	7	201.1	15	231.9	23
157.9	7.25	202.3	15.25	232.8	23.25
159.7	7.5	203.4	15.5	233.6	23.5
161.4	7.75	204.4	15.75	234.4	23.75
163.1	8	205.5	16	235.2	24

Limitations

1. For tgts greater than 2.35 m in circumference use borehole charges.
2. Total charge size suggested to be used to create an abatis while leaving trees attached to stump is 80% of charge size in table.
3. Recommend test shots always be carried out.

805.42 - CUTTING CHARGE MASONRY AND UN-REINFORCED CONCRETE

1. Charge End Cross Sect For Blocks of C4

Wall Thickness (cm)	C _x (C4)	Pier Thickness (cm)	C _x (C4)	Pier Thickness (cm)	C _x (C4)	Arch Ring Thickness (cm)	C _x (C4)	Arch Ring Thickness (cm)	C _x (C4)
50	1	43	1	138	10.25	40	1	130	10.25
56	1.25	48	1.25	140	10.5	45	1.25	132	10.5
61	1.5	53	1.5	142	10.75	50	1.5	133	10.75
66	1.75	57	1.75	143	11	54	1.75	135	11
70	2	61	2	145	11.25	57	2	136	11.25
75	2.25	65	2.25	146	11.5	61	2.25	138	11.5
79	2.5	68	2.5	148	11.75	64	2.5	139	11.75
82	2.75	71	2.75	150	12	67	2.75	141	12
86	3	75	3			70	3	142	12.25
90	3.25	78	3.25			73	3.25	144	12.5
93	3.5	81	3.5			76	3.5	145	12.75
96	3.75	83	3.75			79	3.75	147	13
100	4	86	4			81	4	148	13.25
103	4.25	89	4.25			84	4.25	150	13.5
106	4.5	91	4.5			86	4.5	151	13.75
109	4.75	94	4.75			89	4.75	152	14
111	5	96	5			91	5		

Wall Thickness (cm)	C _x (C4)	Pier Thickness (cm)	C _x (C4)	Pier Thickness (cm)	C _x (C4)	Arch Ring Thickness (cm)	C _x (C4)	Arch Ring Thickness (cm)	C _x (C4)
114	5.25	99	5.25			93	5.25		
117	5.5	101	5.5			95	5.5		
119	5.75	103	5.75			97	5.75		
122	6	106	6			100	6		
125	6.25	108	6.25			102	6.25		
127	6.5	110	6.5			104	6.5		
129	6.75	112	6.75			106	6.75		
132	7	114	7			108	7		
134	7.25	116	7.25			109	7.25		
136	7.5	118	7.5			111	7.5		
139	7.75	120	7.75			113	7.75		
141	8	122	8			115	8		
143	8.25	124	8.25			117	8.25		
145	8.5	126	8.5			119	8.5		
147	8.75	128	8.75			120	8.75		
150	9	129	9			122	9		
		131	9.25			124	9.25		
		133	9.5			125	9.5		
		135	9.75			127	9.75		

Wall Thickness (cm)	C _x (C4)	Pier Thickness (cm)	C _x (C4)	Pier Thickness (cm)	C _x (C4)	Arch Ring Thickness (cm)	C _x (C4)	Arch Ring Thickness (cm)	C _x (C4)
		136	10			129	10		

2. **Charge Calculation.** Charges used for cutting masonry and unreinforced concrete can be calculated using the fol formula:

$C = \frac{LC \text{ (cm)}}{\text{length of block}} \times C_x$	C = charge reqr blocks of c4 LC = length of cut (m) C _x = charge end cross sect
NOTE: For tgts thicker than 1.5 m use borehole charges.	

805.43 - CUTTING CHARGE RECTANGULAR STEEL

1. Cutting Charge Rectangular Steel Charge End Cross Sect For Blocks of C4

Beam Thickness (m)	C _x (C4)	Beam Thickness (m)	C _x (C4)	Slab Thickness (m)	C _x (C4)
0.056	1	0.179	10.25	0.079	1
0.062	1.25	0.181	10.5	0.088	1.25
0.068	1.5	0.183	10.75	0.096	1.5
0.074	1.75	0.185	11	0.104	1.75
0.079	2	0.187	11.25	0.111	2
0.083	2.25	0.189	11.5	0.118	2.25
0.088	2.5	0.191	11.75	0.125	2.5
0.092	2.75	0.193	12	0.131	2.75
0.096	3	0.195	12.25	0.137	3

Beam Thickness (m)	C_x (C4)	Beam Thickness (m)	C_x(C4)	Slab Thickness (m)	C_x (C4)
0.100	3.25	0.197	12.5	0.142	3.25
0.104	3.5	0.199	12.75	0.148	3.5
0.108	3.75	0.201	13	0.153	3.75
0.111	4	0.203	13.25	0.158	4
0.115	4.25	0.205	13.5	0.163	4.25
0.118	4.5	0.207	13.75	0.167	4.5
0.121	4.75	0.209	14	0.172	4.75
0.125	5	0.211	14.25	0.176	5
0.128	5.25	0.212	14.5	0.181	5.25
0.131	5.5	0.214	14.75	0.185	5.5
0.134	5.75	0.216	15	0.189	5.75
0.136	6	0.218	15.25	0.193	6
0.139	6.25	0.220	15.5	0.197	6.25
0.142	6.5	0.221	15.75	0.201	6.5
0.145	6.75	0.223	16	0.205	6.75
0.147	7	0.225	16.25	0.209	7
0.150	7.25			0.212	7.25
0.153	7.5			0.216	7.5
0.155	7.75			0.220	7.75
0.158	8			0.223	8
0.160	8.25			0.225	8.25

Beam Thickness (m)	C _x (C4)	Beam Thickness (m)	C _x (C4)	Slab Thickness (m)	C _x (C4)
0.163	8.5				
0.165	8.75				
0.167	9				
0.170	9.25				
0.172	9.5				
0.174	9.75				
0.176	10				

- a. **Charge Calculation.** Charges used for cutting reinforced concrete up to 22.5 cm can be calculated using the following formula:

$C = \frac{LC \text{ (cm)}}{\text{length of block}} \times C_x$	C = charge reqd blocks of C4 Lc = length of cut (m) C _x = charge end cross sect
NOTE: For tgts thicker than 22.5 cm use borehole or concrete stripping charges.	

2. **Cutting Charge Rectangular Steel Charge End Cross Sect for Blocks of C4**

Steel Thickness (cm)	C _x (C4)	Steel Thickness (cm)	C _x (C4)	Steel Thickness (cm)	C _x (C4)
2.7	1	7.4	7.25	10.1	13.5
3.0	1.25	7.5	7.5	10.2	13.75
3.3	1.5	7.6	7.75	10.3	14
3.6	1.75	7.7	8.0	10.4	14.25
3.9	2	7.9	8.25	10.5	14.75

Steel Thickness (cm)	C_x (C4)	Steel Thickness (cm)	C_x (C4)	Steel Thickness (cm)	C_x (C4)
4.1	2.25	8.0	8.5	10.6	15
4.3	2.5	8.1	8.75	10.7	15.25
4.5	2.75	8.2	9.0	10.8	15.5
4.7	3	8.3	9.25	10.9	15.75
4.9	3.25	8.4	9.5	11.0	16
5.1	3.5	8.6	9.75	11.1	16.25
5.3	3.75	8.7	10	11.2	16.75
5.5	4	8.8	10.25	11.3	17
5.6	4.25	8.9	10.5	11.4	17.25
5.8	4.5	9.0	10.75	11.5	17.5
6.0	4.75	9.1	11	11.6	17.75
6.1	5	9.2	11.25	11.7	18.25
6.3	5.25	9.3	11.5	11.8	18.5
6.4	5.5	9.4	11.75	11.9	18.75
6.6	5.75	9.5	12	12.0	19
6.7	6	9.6	12.25	12.1	19.5
6.8	6.25	9.7	12.5	12.2	19.75
7.0	6.5	9.8	12.75	12.3	20
7.1	6.75	9.9	13		
7.2	7	10.0	13.25		

a. **Formula for Calculating Cutting Charges for Rectangular Structural Steel Sects:**

$C_x = \frac{T^2}{380} \times \frac{\text{length of block (cm)}}{\text{weight of block (kg)}}$ $C = \frac{LC \text{ (cm)}}{\text{length of block}} \times C_x$	where C_x = charge end cross sect T = tgt thickness (cm) C = charge reqr (blocks of c4) LC = length of cut (cm)
NOTE: in this instance, the value of C_x can never be less than 1.0	

805.44 - BREACHING CHARGES

1. **Hasty Method.** Breaching charges make use of the shattering effect of expls. They provide a rough method of destroying reinforced concrete piers and obs such as dragon's teeth, cubes, tetrahedrons, and walls. Breaching charges are suitable (as an altn to shaped charges) for attacking RC piles, RC piers (up to 1 m thick), and trestles.

a. **Charge calculations**

SER	TGT	WT OF EXPL (KG) PER M3 OF MAT TO BE REMOVED	REMARKS
(a)	(b)	(c)	(d)
1	RC obs, e.g. blocks, dragon's teeth, and cubes	16	If reinforcement is hy, double charge
2	Masonry walls with no reinforcement	16	Length of wall atked should not be less than height
3	RC walls with reinforcement no denser	32	As for ser 2

SER	TGT	WT OF EXPL (KG) PER M3 OF MAT TO BE REMOVED	REMARKS
(a)	(b)	(c)	(d)
	than 23 cm spacing		
4	RC piers, and walls, with reinforcement denser than 23 cm spacing	64	As for ser 2

NOTES:

- Determine the kg/m^3 by the type of tgt from above table multiply by the m^3 of the tgt to be destroyed to get the charge qty in kg.
- Divide the charge qty by the wt of expl to be used, to get the total charge qty in units of issue, i.e. blocks of C4.

2. Concrete Stripping Charge Per Metre Run

THICKNESS (m)	C_w kg (m)	C_w C4 BLOCKS	W_d (m)	THICKNESS (m)	C_w kg (m)	C_w C4 BLOCKS	W_d (m)
0.05	0.44	1.00	0.4	1.05	93.50	167.00	2.4
0.10	0.86	1.75	0.5	1.10	105.67	188.75	2.5
0.15	1.48	2.75	0.6	1.15	118.84	212.25	2.6
0.20	2.34	4.25	0.7	1.20	133.07	237.75	2.7
0.25	3.49	6.25	0.8	1.25	148.40	265.00	2.8
0.30	4.96	9.00	0.9	1.30	164.85	294.50	2.9
0.35	6.80	12.25	1.0	1.35	182.48	326.00	3.0

THICKNESS (m)	C _w kg (m)	C _w C4 BLOCKS	W _d (m)	THICKNESS (m)	C _w kg (m)	C _w C4 BLOCKS	W _d (m)
0.40	9.04	16.25	1.1	1.40	201.33	359.75	3.1
0.45	11.73	21.00	1.2	1.45	221.42	395.50	3.2
0.50	14.91	26.75	1.3	1.50	242.82	433.75	3.3
0.55	18.61	33.25	1.4	1.55	265.55	474.25	3.4
0.60	22.88	41.00	1.5	1.60	289.65	517.25	3.5
0.65	27.76	49.75	1.6	1.65	315.17	563.00	3.6
0.70	33.28	59.50	1.7	1.70	342.15	611.00	3.7
0.75	39.50	70.75	1.8	1.75	370.62	662.00	3.8
0.80	46.44	83.00	1.9	1.80	400.63	715.50	3.9
0.85	54.15	96.75	2.0	1.85	432.22	772.00	4.0
0.90	62.67	112.00	2.1	1.90	465.43	831.25	4.1
0.95	72.05	128.75	2.2	1.95	500.30	893.50	4.2
1.00	82.31	147.00	2.3	2.00	536.87	958.75	4.3

a. **Charge Calculation.** Concrete Stripping Charges can be calculated using the fol formula:

$C = C_w \times W$	C = Charge reqr blocks of C4 W = the width of beam or sect of slab to be cut C _w = the size of charge per m of concrete
NOTE: For tgts thicker than 2 m use borehole charges.	

805.45 - BOREHOLE CHARGES

1. **Borehole Charges in Round Timber.** To be used to destroy wooden trestles, brs or timber structures, and land clr

SER	DIA OR AVG THICKNESS OF TGT (cm)	No. OF BOREHOLES	TOTAL CHARGE (kg)	TOTAL CHARGE BLOCKS OF C4
1	26	1	0.14	.25
2	37	1	0.27	.5
3	46	1	0.42	.75
4	53	1	0.56	1
5	59	2	0.70	1.25
6	64	2	0.82	1.5
7	70	2	98	1.75
8	74	2	1.10	2
9	79	2	1.25	2.25
10	83	2	1.38	2.5
11	87	2	1.51	2.75
12	91	2	1.66	3
13	95	2	1.81	3.25
14	99	2	1.96	3.5
15	102	2	2.08	3.75
16	105	2	2.21	4
17	109	2	2.38	4.25

SER	DIA OR AVG THICKNESS OF TGT (cm)	No. OF BOREHOLES	TOTAL CHARGE (kg)	TOTAL CHARGE BLOCKS OF C4
18	112	2	2.51	4.5
19	115	2	2.65	4.75
20	118	2	2.78	5

NOTE: The blocks of C4 have been rounded up to the nearest quarter. In some instances there may be surplus expl when the borehole has been filled.

$C = \frac{2(d)^2}{100}$	C = charge reqr (kg) d = dia (cm)
NOTES: 1. Tgts up to 0.5-m diam 1 hole reqr. 2. Tgts over 0.5 m diam 2 holes reqr, expls divided equally in 2 holes.	

2. Borehole Charges in Masonry and Concrete

SER	DEPTH OF HOLE (m)	VOL PER HOLE (cm ³)	C4 PER BOREHOLE REINFORCED CONCRETE		C4 PER BOREHOLE MASONRY AND UNREINFORCED CONCRETE	
			kg C4	Blks C4	kg C4	Blks C4
(a)	(b)	(c)	(d)	(e)	(f)	(g)
1	0.4	785.60	1.26	2.25	.63	1.25
2	0.6	1178.40	1.89	3.5	.94	1.75
3	0.8	1571.20	2.51	4.5	1.26	2.25
4	1	1964.00	3.14	5.75	1.57	3.00
5	1.2	2356.80	3.77	6.75	1.89	3.5
6	1.4	2661.00	4.26	7.75	2.13	4.00
7	1.6	2965.20	4.74	8.5	2.37	4.25
8	1.8	3269.40	5.23	9.5	2.62	4.75
9	2	3496.20	5.59	10	2.80	5.00
10	2.2	3723.00	5.96	10.75	2.98	5.5
11	2.4	3949.80	6.32	11.5	3.16	5.75

NOTES:

1. The blocks of C4 have been rounded up to the nearest quarter. In some instances there may be surplus expl when the borehole has been filled.
2. Based on vol of expl and borehole.

3. Placement of Borehole Charges

SER	MATERIAL	THICKNESS	No. OF HORIZONTAL ROWS	VERTICAL SPACING	DEPTH OF HOLES
(a)	(b)	(c)	(d)	(e)	(f)
1	Brick or Masonry	Up to 1.80 m	2	2T/3	2T/3
2	Plain or Reinforced Concrete	Up to 1.80 m	3	2T/3	2T/3
3	Brick, Masonry, Plain or Reinforced Concrete	1.80 m to 2.70 m	3	2T/3	2T/3
4	Brick, Masonry, Plain or Reinforced Concrete	2.70 m to 3.60 m	3 each side	2T/3	T/2
5	Brick, Masonry, Plain or Reinforced Concrete	2.70 m to 3.60 m	3	2T/3	2T/3
6	Brick, Masonry, Plain or Reinforced Concrete	3.60 m to 4.80 m	3 each side	2T/3	T/2

NOTE: When using drill rods up to 1.8 m in length, on tgts of thickness 2.7 m or less you can drill from one side, however from 2.7 m to 3.6 m thick, holes must be drilled from both sides. Similarly, when using 2.4-m drill rods in length, tgts up to 3.6 m can be drilled from one side, but tgts from 3.6 m to 4.8 m must be drilled from both sides.

805.46 - MINED CHARGES**1. Mined Charges for Cratering**

SUBGRADE	HOLE SPACING(S) (m)	EXPECTED CRATER DIAM (m)	No. OF HOLES	MIN CHARGE QUANTITY (kg)
(a)	(b)	(c)	(d)	(e)
Soft Grd	2D	3D	W/S	$(9/4)D^3$
Med Grd	2D	3D	W/S	$(9/2)D^3$
Hard Grd	D	2D	W/S	$(9/2)D^3$

Where:
D = depth of hole in m (camouflet set d = 2m, auger d = 2.4m)
W = the length of desired cut in m

- a. For placement of charges use the fol procedures (utilising the table above):
 - (1) determine charge depth normally 2 m or 2.4 m and type of grd;
 - (2) determine charge spacing;
 - (3) determine expected size;
 - (4) determine line of cut. From craters across a rd at a 45 degree angle, multiply the width of rd by 1.41, (which is an equal to 1/cosine of 45 degrees);
 - (5) determine the no of holes; and
 - (6) determine the no of rows reqr which in most cases would be three and multiply that no by the no of holes.
- b. For determining charge size carry out the fol steps:
 - (1) determine charge quantity;
 - (2) multiply the no of holes by charge quantity; and
 - (3) multiply 0.5 block of C4 per hole as a priming charge.

2. Calculations for Continuous Mined Charges

SER	NATURE OF SOIL	Wt OF CHARGE (kg) OF C4 PER M RUN	REMARKS
(a)	(b)	(c)	(d)
1	Soft Grd (Sand, Gravel, Clay)	$4 d^2/25$ or $2 L_r^2/25$	1. D = Dia or width of crater (m) 2. L_r = Least line of resistance (m) 3. If the surface is a concrete slab or hy pavement, increase the charge by 50%
2	Med Grd	$8 d^2/25$ or $4 L_r^2/25$	
3	Hard Grd (Rock)	$16 d^2/25$ or $8 L_r^2/25$	

3. Mined Charges for Masonry and Concrete Abutments and Retaining Walls

Ser	Distance (M) From Face L_r (I)	Depth (m) $D=3L_r/2$ (II)	Masonry And Plain Concrete												Reinforced Concrete		
			Contin-uous Buried Charges $8 L_r^2/3$ (kg/m run)	Small Buried Charges		Continuous Charges For Crater Dia (d)									Cratering Charges For Crater Dia (D)		
				Charge $2L_r^3$ (kg)		Spacing $4L_r/3$ (m)			$d = 2.5 L_r$			$d = 3L_r$			$d = 3L_r$		
						d (m)	Charge $d^3/3$ (kg)	Spacing $2d/3$ (m)	d (m)	Charge $d^3/3$ (kg)	Spacing $2d/3$ (m)	d (m)	Charge $d^3/3$ (kg)	Spacing $2d/3$ (m)	d (m)	Charge $d^3/3+10$ (kg)	Spacing $2d/3$ (m)
(a)	(b)	(c)	(d)	(e)	(f)	(g)	(h)	(i)	(j)	(k)	(l)	(m)	(n)	(o)	(p)	(q)	(r)
1	0.6 m or less	0.9	1.0	0.5	0.8	1.2	0.75	0.8	1.5	1.25	1.0	1.8	3.0	1.2	1.8	13.0	1.2
2	0.8	1.2	1.75	1.0	1.1	1.6	1.5	1.1	2.0	2.75	1.3	2.4	4.75	1.6	2.4	15.0	1.6
3	1.0	1.5	2.75	2.0	1.3	2.0	2.75	1.3	2.5	5.25	1.7	3.0	9.0	2.0	3.0	19.0	2.0
4	1.2	1.8	4.0	3.5	1.6	2.4	4.75	1.6	3.0	9.0	2.0	3.6	15.5	2.4	3.6	25.5	2.4

Ser	Distance (M) From Face L_r (I)	Depth (m) $D=3L_r/2$ (II)	Masonry And Plain Concrete												Reinforced Concrete			
			Contin-uous Buried Charges $8 L_r^2/3$ (kg/m run)	Small Buried Charges		Continuous Charges For Crater Dia (d)										Cratering Charges For Crater Dia (D)		
				Charge $2L_r^3$ (kg)		Spacing $4L_r/3$ (m)			$d = 2.5 L_r$			$d = 3L_r$				$d = 3L_r$		
						d (m)	Charge $d^3/3$ (kg)	Spacing $2d/3$ (m)	d (m)	Charge $d^3/3$ (kg)	Spacing $2d/3$ (m)	d (m)	Charge $d^3/3$ (kg)	Spacing $2d/3$ (m)	d (m)	Charge $d^3/3+10$ (kg)	Spacing $2d/3$ (m)	
(a)	(b)	(c)	(d)	(e)	(f)	(g)	(h)	(i)	(j)	(k)	(l)	(m)	(n)	(o)	(p)	(q)	(r)	
5	1.4	2.1	5.25	5.5	1.9	2.8	7.5	1.9	3.5	14.5	2.3	4.2	25.0	2.8	4.2	35.0	2.8	
6	1.6	2.4	7.0	8.25	2.1	3.2	11.0	2.1	4.0	21.5	2.7	4.8	37.0	3.2	4.8	47.0	3.2	
7	1.8	2.7	8.75	11.75	2.4	3.6	15.5	2.4	4.5	30.5	3.0	5.4	52.5	3.6	5.4	62.5	3.6	
8	2.0	3.0	10.75	16.0	2.7	4.0	21.5	2.7	5.0	42.0	3.3	6.0	72.0	4.0	6.0	82.0	4.0	
9	2.2	3.3	13.0	21.25	2.9	4.4	28.5	2.9	5.5	55.5	3.7	6.6	96.0	4.4	6.6	106.0	4.4	
10	2.4	3.6	15.5	27.75	3.2	4.8	37.0	3.2	6.0	72.0	4.0	7.2	124.5	4.8	7.2	134.5	4.8	

Ser	Distance (M) From Face L_r (I)	Depth (m) $D=3L_r/2$ (II)	Masonry And Plain Concrete												Reinforced Concrete			
			Contin-uous Buried Charges $8 L_r^2/3$ (kg/m run)	Small Buried Charges		Continuous Charges For Crater Dia (d)										Cratering Charges For Crater Dia (D)		
				Charge $2L_r^3$ (kg)		Spacing $4L_r/3$ (m)			$d = 2.5 L_r$			$d = 3L_r$				$d = 3L_r$		
						d (m)	Charge $d^3/3$ (kg)	Spacing $2d/3$ (m)	d (m)	Charge $d^3/3$ (kg)	Spacing $2d/3$ (m)	d (m)	Charge $d^3/3$ (kg)	Spacing $2d/3$ (m)	d (m)	Charge $d^3/3+10$ (kg)	Spacing $2d/3$ (m)	
(a)	(b)	(c)	(d)	(e)	(f)	(g)	(h)	(i)	(j)	(k)	(l)	(m)	(n)	(o)	(p)	(q)	(r)	
11	2.6	3.9	18.0	35.25	3.5	5.2	49.0	3.5	6.5	92.0	4.3	7.8	158.0	5.2	7.8	168.0	5.2	
12	2.8	4.2	21.0	44.0	3.7	5.6	58.5	3.7	7.0	114.5	4.7	8.4	198.0	5.6	8.4	208.0	5.6	
13	3.0	4.5	24.0	54.0	4.0	6.0	72.0	4.0	7.5	141.0	5.0	9.0	243.0	6.0	9.0	253.0	6.0	

805.47 - CONCUSSION CHARGES

1. **Charge Calculation.** Concussion charge calculation is broken down into three categories by the tgt const:

- unreinforced const such as, corrugated iron, timber, or brick,
- lt reinforced const, and
- re-inforced concrete (RC) such as bldgs and defs.

2. **Unreinforced Const.** Unreinforced construction is further broken down IAW the wall thickness:

- For bldgs with walls that do not exceed 0.35 m use the fol formula:

$C = V/3$	Where $C = \text{Charge Size (kg)}$ $V = \text{Internal Vol (m}^3\text{)}$
-----------	---

- Charges in bldgs of two or more stories need only be calculated for the grd floor. If all openings can be blocked efficiently, the charges based on the formula may be halved.

- For bldgs with walls that exceed 0.35 m thick use the fol formulas:

$C = VT/2$	Where $C = \text{Charge Size (kg)}$ $V = \text{Internal Vol (m}^3\text{)}$ $T = \text{Thickness of Exterior Wall(m)}$
------------	---

- lt reinforced construction. For bldgs of lt reinforced const use the fol formula:

$C = VT$	Where $C = \text{Charge Size (kg)}$ $V = \text{Internal Vol of Grd Floor, Incl Interior Walls(m}^3\text{)}$ $T = \text{Thickness of Exterior Walls (m), Min 0.30 m}$
----------	--

- RC Bldgs and Fortifications.** For RC bldgs and fortifications use the fol formula:

$C = 16KT$ (VT)	Where $C = \text{Charge Size (kg)}$ $K = \text{A factor (fol table) depending on:}$ (1) the str of mat used in const; (2) the shape of the structure; and (3) the no of openings or weak spots in the walls and roof, through which the effect of the charge may be dissipated $T = \text{Wall Thickness (m). However, if the roof thickness is greater than the wall thickness and is also greater than one-third the internal height, then } T = \text{roof thickness (m)}$ $V = \text{Internal vol of structure (incl all internal walls floors, etc.) (m}^3\text{)}$
--------------------	--

- Values for K (for Concussion Charge Calculations - RC Bldgs and Foundations)

SER	TYPE OF STRUCTURE	VALUE OF k
(a)	(b)	(c)
1	Brick structures up to 30 m ³ internal vol with walls up to 0.6 m thick (surface or semi-buried)	0.1
2	Brick structures of internal vol larger than 30 m ³	0.2 - 0.4
3	RC air raid shelters (surface or below grd with not	0.4

SER	TYPE OF STRUCTURE	VALUE OF k
(a)	(b)	(c)
	more than 1.5 m of cover)	
4	RC tunnels in normal soil (calculate charge for each 30 m run)	1.0
5	RC fortifications with walls up to 0.6 m thick	0.4
6	RC fortifications with walls over 0.6 m to 1.2 m thick	0.7
7	RC fortifications with walls over 1.2 m thick	1.1

805.48 - EXPLOSIVE DIGGING

1. For the std battle trench 4 m long x 1.4 m deep, use 4 holes 1.1 m deep spacing with $\frac{1}{4}$ block of C4 per hole. If the grd is hard, increase C4 by $\frac{1}{4}$ block increments as reqr.

805.49 - FIRING CIRCUITS

1. Simple Firing Circuit

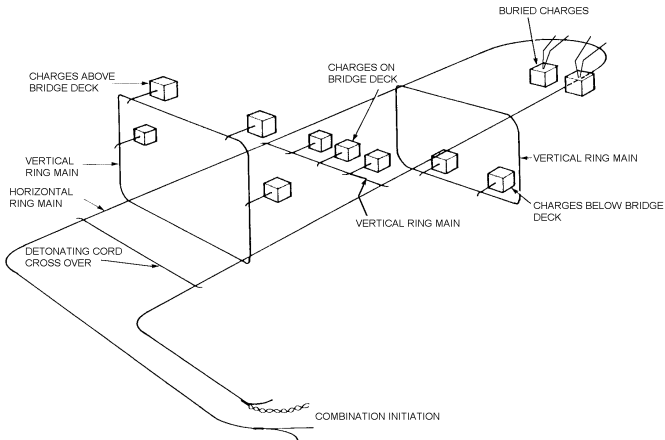

2. Max Firing Circuit

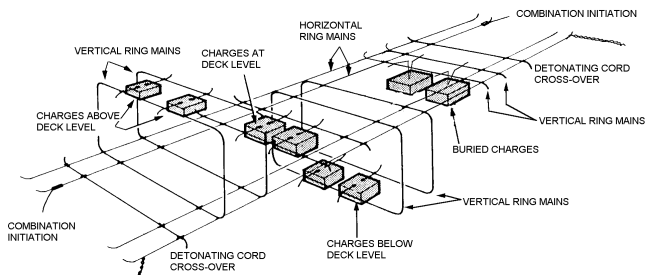

SUSTAINMENT ENGINEERING

805.50 - WATER SUP

1. Sources

Ser	Source	Quality	Yield	Remarks
(a)	(b)	(c)	(d)	(e)
1	Large lakes	Usually good	Amplly	Draw water as far away as possible from mouths of inlets
2	Ponds	Usually contaminated and muddy	Small, temporary sup. Measure voltrically	Fence. Prohibit washing and bathing. Cut weeds, fit pumps with floating strainers well away from bank
3	Streams and rivers	Liable to be contam	Est by velocity method	Investigate variations in water level. Prohibit washing and bathing upstream. Consider dam to increase storage and depths of water
4	Springs	a. Perennial, usually good b. "Land" springs liable to be polluted	Time to fill vessel of known capacity	Take from stream if formed. Otherwise dig collecting chamber
5	Wells and boreholes	Shallow wells may be polluted	Use recuperation test	
6	Piped supplies	Good but may require tmt, e.g. fire hydrant supply	Ample but dependent on distr of sup	Determine during recce.

2. **Allowable Raw Water Constituents.** The fol table is a summary of the allowable raw water constituents for determining the prelim type of process reqr in tmt of raw water.

Constituents	Range
Free chlorine	0 to 2.5 mg/L Chloride (Cl)
Oil and Grease	Absence – Visual/Smell
PH	1 to pH units
Hardness, Total	0 to 500mg/L Calcium Carbonate (CaCO ₃)
Temp	O C to 50 C
Total Disolved Solids	0 to 20 g/L as Salt (NaCl)
Turbidity	0 to 1000 NTU

3. **Toxic Substances.** Drinking water must not contain more of the fol substances that the qty shown.

Arsenic 2 mg/l	Mustard gas 0.2 mg/l
Cyanide 20 mg/l	Nerve agent 0.02 mg/l

4. **WS Recce Checklist**

<p>a. Prelim planning (1) Map Recce. Potential loc of WP, en sit and likely loc of BG echs (2) Recce Plan. Itinerary likely locs, timings est, rtes and tpt reqr (3) Recce Eqpt. Quality analysis set, proformas and gen recce stores</p>	<p>b. Info Reqr (1) Quality of water. Record results of analysis and info on pollution or other environ hazards. (2) Calculate yield and determine if water source will be constant for life of WP (3) Approaches to Sources. Adequate in/out rtes, width, surface, slope and MLC (4) Nature of Site. Recce report must incl an accurate and detailed description of site, type of source, grd and vegetation, loc of eqpt and proposed layout of WP</p>	<p>(5) Cam and Concealment. WP are to be concealed. Describe method of concealment and any seasonal changes that may affect the WP (6) Dispersal Areas. WA and dispersal areas (7) Work Est for Immed Ops. Suggest setup and future developments of the WP incl work est (8) Site Sketch (9) Description and Sketch of Proposed Development</p>
---	--	---

5. **Yield of Source**

a. **Determine Velocity (V)**

$$V = \text{distance in meters} \div \text{time in seconds} = \text{m/sec}$$

b. **Determine Approximate Cross Sectional Area of Source.**

NOTE: Source should be sounded at four sites and at least four times across its width at each site.

Depths in meters						÷ 4 = average	X width	= Area
@	1	2	3	4	Total			
A								
B								
C								
D								
Total Area								$\frac{\quad}{4} \text{m}^2$
= Average Cross Section of Source								m^2

c. **Determine Yield of Source**

Velocity (step 1) _____ m/sec
 Area (step 2) _____ m²
 Conversion of m³ to litres _____ x _____ 1000
 Conversion of seconds to minutes _____ x 60
 Safety factor of 80% - x 0.8
 All Constants (0.8 x 1000 x 60) = 48,000

d. **Determine Yield at Source**

Yield = V x _____ A x 48,000 = _____ Litres/min
 Yield = _____ m/sec x _____ m² x 48,000 = _____ litres/min

6. **Characteristics of WS Eqpt**

Ser	Design features	Production rate	Operating temp
(a)	(c)	(d)	(e)
ROWPU	Reverse osmosis	Max 5000 l/hr for single pass and 2400l/hr for double pass	Air -40C to 49C Water 3C to 40C
SUWPS	Reverse osmosis (1)	250 l/hr. Raw water intake is approx 500 l/hr.	Air -40C to 49C Water 4 to 40C
IWP	Stage 1 – pre-filter removes particles as small as 74 microns Stage 2 – destroys bacteria, protozoa and viruses by using a composite resin purification Stage 3 – granular activated carbon removes any residual taste and odour	2 l/min Max use of cartridge 4000 l	Do not allow system to freeze

Onion Tk	Capacity – filled 11,365 L Dia of collar opening 1.83 m Dia at base 3.6 m Dry wt 63 kg Height of water (max) 1.22 Avg instl time 5 – 8 min m
Water Bagger	System contained in a sea container complete with 10Kw generator 1000 blue plastic bags per container dimensions 30 cm x 45 cm x 45 cm Capacity 5000 one litre bags per hr
NOTE: Do not use feed water that is chlorinated (i.e. municipal water sup) or that has been contam with smells of gasoline, diesel fuel or oil.	

SURVIVABILITY

805.51 - CONSTRUCTION MATERIALS

1. Permissible Working Stresses – Timber

Ser	Gp	Density t/m ³	Permissible Stress (mpa = kpa X 10 ³)			
			Bend- ing	Compression Along Grain	Shear Along Grain	Compression n Across Grain
(a)	(b)	(c)	(d)	(e)	(f)	(g)
1	I - Common Hardwood of Great Str	1.0	28.0	17.0	4.0	4.6
2	II - Common Med Str Hardwoods and a Few Superior Softwoods	0.8	20.0	11.0	2.8	2.4
3	III - Med Str Softwoods and Low Str Hardwoods. This Gp Contains Most of the Timber for Br Construction	0.7	15.0	8.5	2.1	2.0
4	IV - Low Str Softwoods and Inferior or Defective Gp III Timber	0.65	12.5	7.0	1.8	1.5

NOTE: This table is based on timber which is green or wet (but not defective) in structures such as temp br subj to intermittent loading. In other conditions the stress must be multiplied by the reduction factors given below. If two or more conditions apply the factors must be multiplied together.

Condition	Factor
a. Semi-permanent construction	0.8 to 0.7
b. Continuous loading	0.7
c. Defective timber	0.8 to 0.5

2. Timber Wts and Specific Gravity

Type	Wt Lbs/cu.Ft	Specific Gravity	Type	Wt Lbs/ cu.Ft	Specific Gravity
Ash, White, Red	40	0.62-0.65	Cedar, White, Red	22	0.32-0.38
Chestnut	41	0.66	Cypress	30	0.48
Fir, Douglas Spruce	32	0.51	Fir, Eastern	25	0.40
Elm, White	45	0.72	Hemlock	29	0.42-0.52
Hickory	49	0.74-0.84	Locust	46	0.73
Maple, Hard	43	0.68	Maple, White	33	0.53
Oak, Chestnut	54	0.86	Oak, Live	59	0.95
Oak, Red, Black	41	0.65	Oak, White	46	0.74
Pine, Oregon	32	0.51	Pine, Red	30	0.48
Pine, White	26	0.41	Pine, Yellow, Long-leaf	44	0.70
Pine, Yellow, Short-leaf	38	0.61	Poplar	30	0.48
Redwood, California	26	0.42	Spruce, White, Black	27	0.40-0.46
Walnut, White	38	0.61	Walnut, Black	26	0.41

NOTE: Moisture content by wt: seasoned timber 15 % to 20 %, green timber up to 50 %.

3. Permissible Working Stresses in Metals

Ser	Metal	Permissible Stress - N/mm ²			
		Tension	Bending	Shear	Bearing
(a)	(b)	(c)	(d)	(e)	(f)
1	High yield steel rolled beams	210	225	135	270
2	Mild steel rolled beam	150	165	95	190
3	Mild steel doubtful quality	125	125	80	160
4	Wrought iron	120	125	80	160
5	Cast iron	55	-	30	16

GEOMATICS

805.52 - DATA TYPES

1. **Analogue or Hard Copy.** Typical analogue products incl std hard copy maps or charts at various scales. Response products incl image maps, terrain studies, photo mosaics and terrain analysis products.
2. **Raster Data.** Consists of geo-referenced pixels or cells and is suitable for background displays.
3. **Vector Data.** Contains geo-referenced pts, lines or area features and related attributes. Vector data is “intelligent data” and sp queries or analysis. Vector data is sp by most Geographic Information Systems (GIS).
4. **Matrix Data.** A uniform grid of heights or depths, which can be compared to “mosquito netting”, where at every intersection, an elevation or depth is provided. This data is well suited for line of sight views, profiles and 3D visualization.

805.53 - GEOSPACIAL PRODUCTS

1. **Vector Smart Map (VMap).** VMap provides vector based geospatial info at various resolutions (Level 0,1,2 and 3). The vector data is separated into 10 themes or layers. Aval: Level 0 – global coverage, Level 1 – estimated to be complete 2002, Level 2 – to be replaced with Foundation Feature Data (FFD), Level 3 – to be repl with FFD. Applic: GIS, C2IS, wpn systems.
2. **ARC Digitized Raster Graphics (ADRG).** ADRG are scanned images of paper maps/charts transformed into the ARC ref system. Approx two-four maps can be scanned onto a single CD-ROM. Aval: ARC 1 (1:1M) - global coverage, ARC 2 (1:500K) – global coverage, ARC 5 (1:250K) global coverage, ARC 7 (1:50K) – limited coverage. Applic: map displays for C2IS.
3. **Compressed ARC Digitized Raster Graphics (CADRG).** Ident to ADRG, except a 55:1 compression algorithm allows more scanned images to be captured on a CD-ROM. Approx 200 scanned maps can be stored on a single CD-ROM. Aval: similar to ADRG. Applic: identical to ADRG plus ac cockpits.
4. **Foundation Feature Data (FFD).** FFD will repl VMap Level 2 and 3 consisting of feature data, elevation data and imagery data which may be provided rapidly to sp msn reqr and later intensified as reqr. Aval: currently not aval. Applic: msn specific at tac level as a response product integrating features, imagery and elevation data.
5. **Digital Terrain Elevation Data (DTED).** A uniform matrix of elevation values at intervals of 300 m (Level 0), 100 m (Level 1) or 30 m (Level 2). Aval: Level 0 – global coverage, Level 1 – 55% global coverage, Level 2 – global coverage by 2002. Applic: line of sight, terrain modeling and profiles, 3D visualization.
6. **Controlled Image Base (CIB).** Geo-ref con imagery used to provide con to remote sensed products. Aval: 10m resolution (unclas) – global

coverage, 5 m resolution (clas) -TBC Applic: rapid response photo maps, background map display.

7. **Digital Nautical Chart (DNC).** DNC is a DIGEST compliant database aval in 4 broad categories: Har (<1:50K), Approach (1:25K-1:100K), Coastal ((1:75K-1:500K) and General (>1:500K). Aval: global coverage by 1999. Applic: ECDIS, SHINPADS, C2IS.

8. **World Vector Shoreline (WVS).** WVS is a database of shorelines, international bdry and country names of the world. WVS has the data density equivalent to a 1:250K map. Aval: currently aval. Applic: C2I